

星级酒店名录

Preformance Table For Hotel Projects

OEM/国外品牌 List Of Oem Client

- SOLA
- ONELDA
- AMEFA
- Nestle
- Zwilling
- ETERNUM signature
- Edelstahl
- GS
- PRAKASH

OEM/国内品牌 Oem/the Chinese Brand

- 山东航空
SHANDONG AIRLINES
- 深圳航空
SHENZHEN AIRLINES
- 好利来蛋糕
HOLLAND
- 哈尔滨远大购物集团
HARBIN BROAD SHOPPING GROUP

- 世界互联网大会
Wic(world Internet Conference)
- 福建融侨大酒店
Rongqiao Hotel Fuqing
- 南京丽湖大酒店
Hotel One Nanjing
- 上海明捷万丽酒店
Renaissance Shanghai Putuo Hotel
- 万和亚龙酒店
Onehome
- 三亚福朋喜来登度假酒店
Foup Pints
- 广州花酒店
The Garden Hotel
- 贵阳喜来登酒店
Sher aton gulyang hotel
- 深圳福鹏喜来登
Fu-Peng Sheraton Shenzhen Hotel
- 中国大酒店
China Hotel
- 北京燕京海航大酒店
Yanjing Hotel Beijing
- 厦门京闽中心酒店
JINGMIN HOTEL
- 宁波威斯汀
Westin Ningbo
- 宁波洲际
Ningbo Intercontinental
- 昆山兰博基尼酒店
tonina Lambozghini
- 广州威斯汀
The Westin PazhouThe Westin Pazhou
- 泉州安溪悦泉行馆
Elite Spring Villas

刀叉餐具的保养 Flatware Care & Handling

- 正确的保养方法可以让优质的镀银以及不锈钢餐具历久常新耐用，以下是我们推荐几步骤。
Fine silverplate and stainless flatware will give you extra long service and will always look great when properly cared for. We offer the following recommendations.

护理： Handling:

- 清洗餐具时，一次转移合理数量餐具用于清洗，数量太多容易碰花餐具。

Minimum amount of handling is required when perforated cylinders in a portable rack are used to transport, wash, and dispense flatware.

清洗： Washing:

- 餐具使用完后应立即将食物残留从餐具清洗，避免使用钢丝球或其他金属利器清洗。

Remove all remnants of food from metalware items immediately after use. Avoid using steel wool or metal scrapers.

- 刀叉与其他金属餐具应在塑料或不锈钢盆中分开浸泡，不可再铝盆中浸泡。

Always separate flatware and holloware for pre-soaking and use a plastic or stainless steel pan, never aluminum.

- 请使用适当温度热水清洗餐具。

Avoid low-temp dishwashing. It is not suited for metalware.

冲洗： Rinsing:

- 若水质太硬，需要使用软化剂，硬水中的氯化物含量太高，会损坏餐具

Utilize a softener if you have very hard water. A high chloride content in the water can also be damaging.

餐具应清洁干燥再储存，以避免餐具产生氧化物或者腐蚀斑。

Storing: Always make sure your metalware is clean and dry before storing to avoid corrosion and oxidation marks.

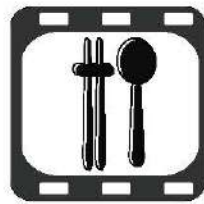

当清洗和贮存不是在同一个容器内进行时，请将餐具功能端（刀、叉、勺面）向上放于清洗容器，清洗完成后再将餐具倒立放置贮存容器。

Always sort flatware tines, bowls and blades down when flatware is transported and washed in the same cylinder. This prevents contamination when items are removed for setting the tables.

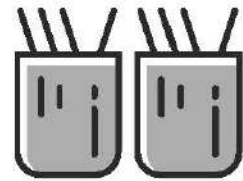

洗碗机应设置空心器皿面朝下启动程序

Load the washing machine with the openings of hollow pieces facing down

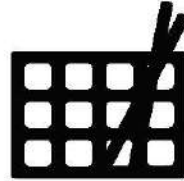

刀叉，空心器皿应分开放置，避免储存过程中碰花。

Separate flatware, holloware and china in bus trays.

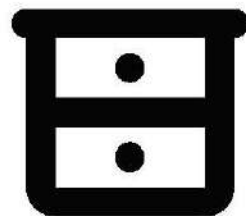

如条件允许，建议在干燥地方使用塑料或木制架贮存餐具。

Keep your holloware pieces together in a dry area. Plastic or wooden racks provide the best storage.

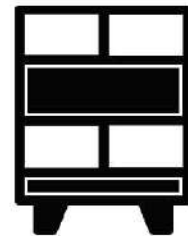

漂洗温度不低于82°C。
Always rinse clean metalware in water of at least 180° F.



餐具摆放标准

Standard Of Tableware Arrangement

早餐 Breakfast

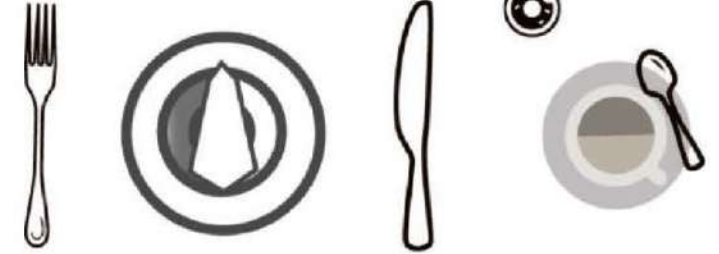

正餐叉
Table Fork

正餐刀
Table Knife

茶更
Tea Spoon

午餐 lunch



黄油刀
Butter Knife

正餐叉
Table Fork

正餐刀
Table Knife

汤更
Soup Spoon

茶更
Tea Spoon

晚餐 Lunch

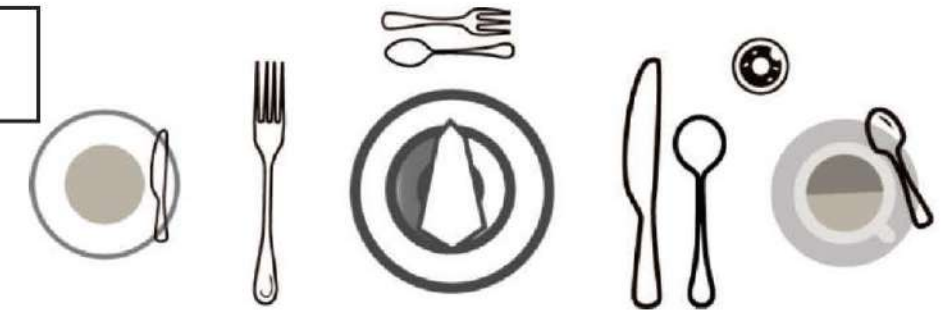

黄油刀
Butter Knife

正餐叉
Table Fork

甜品叉
Dessert Fork

甜品更
Dessert Spoon

正餐刀
Table Knife

汤更
Soup Spoon

茶更
Tea Spoon

中餐 Dinner

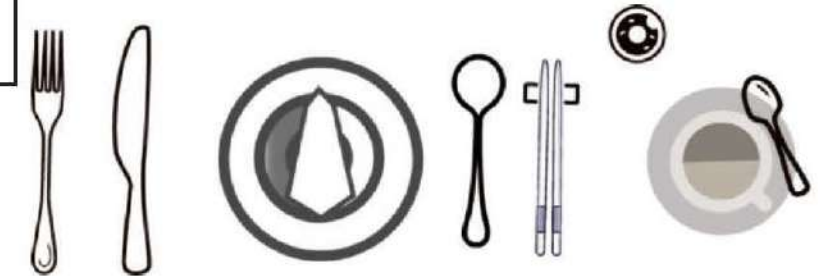

正餐叉
Table Fork

正餐刀
Table Knife

汤更
Soup Spoon

筷子
Chopsticks

茶更
Tea Spoon

宴会 The Banquet



黄油刀
Butter Knife

甜品叉
Dessert Fork

正餐叉
Table Fork

正餐刀
Table Knife

汤更
Soup Spoon

甜品刀
Dessert Knife

茶更
Tea Spoon

甜品更
Dessert Spoon

蛋糕叉
Cake Fork



复古
Restoring ancient ways



镀银
SILVER-PLATED



彩金
Mosaic gold



LOGO
LOGO



镀金
ORO



镀铂金
ORO ICE



镀黑
ORO NERO

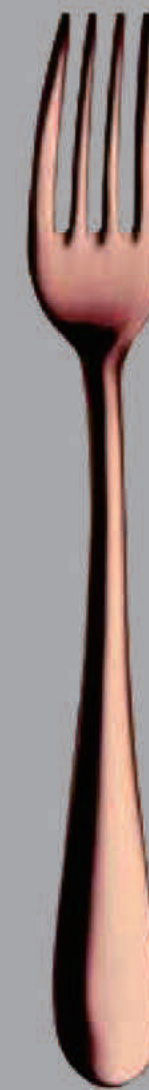

镀玫瑰金
BRONZO

- 所有产品，接受公司名字，LOGO个性化定制服务，采用激光或压制工艺。
All items can be personalized (company name, logo, etc.) using laser engraving or stamping technology.
- 所有材料均符合食品接触检验标准。
All materials used are in accordance with laws governing food and beverages
- 产品符合机洗安全测试。
All items are dishwasher safe

- 表面处理是PVD工艺，在航空航天技术里面应用广泛，表面坚硬耐磨，颜色热情，适合特色的酒店，餐厅和餐饮服务。
The surface treatment is a P.V.D. process (Physical Vapour Deposition) This technology was developed for the aeronautic industry and is used to shield The characteristics of these treatments are hard wearing and hospitality grade -ideal for distinctive hotels, restaurants and catering services.

PITO®

CM118

Stainless Steel
5.0mm

Desc	Size
正餐刀	Table Knife 233mm
正餐叉	Table Fork 201mm
正餐更	Table Spoon 198mm
甜品刀	Dessert Knife 203mm
甜品叉	Dessert Fork 172mm
甜品更	Dessert Spoon 174mm
牛排刀	Steak Knife 227mm
汤更	Soup Spoon 185mm
蛋糕叉	Cake Fork 144mm
水果叉	Fruit Fork 136mm
咖啡更	Coffee Spoon 138mm

Desc	Size
雪糕更	Ice Cream Spoon 163mm
摩卡更	Mocha Spoon 112mm
冰更	Ice Tea Spoon 190mm
黄油刀	Butter Knife 180mm
鱼刀	Fish Knife 195mm
鱼叉	Fish Fork 193mm
小提勺	Gravy Ladle 180mm
大提勺	Soup Ladle 320mm
服务更	Serving Spoon 220mm
服务叉	Serving Fork 220mm



PITO®

Desc	Size
------	------

正餐刀	Table Knife 227mm
正餐叉	Table Fork 220mm
正餐更	Table Spoon 211mm
甜品刀	Dessert Knife 216mm
甜品叉	Dessert Fork 191mm
甜品更	Dessert Spoon 188mm
牛排刀	Steak Knife 240mm
汤更	Soup Spoon 177mm
蛋糕叉	Cake Fork 147mm
水果叉	Fruit Fork 133mm

Desc	Size
------	------

茶更	Tea Spoon 148mm
咖啡更	Coffee Spoon 123mm
黄油刀	Butter Knife 172mm
鱼刀	Fish Knife 210mm
鱼叉	Fish Fork 185mm
小提勺	Gravy Ladle 185mm
大提勺	Soup Ladle 289mm
蛋糕铲	Cake Server 255mm
沙拉叉	Salad Fork 213mm
沙拉更	Salad Spoon 213mm

MC022-C

Stainless Steel
4.0mm



西餐刀叉

MC022

18/10 Stainless Steel
4.0mm

Desc	Size	Desc	Size		
正餐刀	Table Knife	225mm	咖啡更	Coffee Spoon	127mm
正餐叉	Table Fork	219mm	黄油刀	Butter Knife	173mm
正餐更	Table Spoon	210mm	鱼刀	Fish Knife	209mm
甜品刀	Dessert Knife	217mm	鱼叉	Fish Fork	186mm
甜品叉	Dessert Fork	188mm	小提勺	Gravy Ladle	185mm
甜品更	Dessert Spoon	186mm	大提勺	Soup Ladle	280mm
牛排刀	Steak Knife	239mm	蛋糕铲	Cake Server	254mm
汤更	Soup Spoon	176mm	沙拉叉	Salad Fork	212mm
蛋糕叉	Cake Fork	147mm	沙拉更	Salad Spoon	214mm
茶更	Tea Spoon	150mm			



LV006

18/10 Stainless Steel
6.0mm

Desc	Size	Desc	Size		
正餐刀	Table Knife	235mm	咖啡更	Coffee Spoon	110mm
正餐叉	Table Fork	201mm	黄油刀	Butter Knife	178mm
正餐更	Table Spoon	203mm	冰更	Ice Tea Spoon	213mm
甜品刀	Dessert Knife	207mm	鱼刀	Fish Knife	204mm
甜品叉	Dessert Fork	178mm	鱼叉	Fish Fork	202mm
甜品更	Dessert Spoon	175mm	蛋糕铲	Cake Server	247mm
牛排刀	Steak Knife	242mm	小提勺	Gravy Ladle	228mm
汤更	Soup Spoon	188mm	大提勺	Soup Ladle	300mm
茶更	Tea Spoon	145mm	服务更	Serving Spoon	240mm
蛋糕叉	Cake Fork	150mm	服务叉	Serving Fork	240mm
水果叉	Fruit Fork	140mm	二号汤更	2# Soup Spoon	167mm

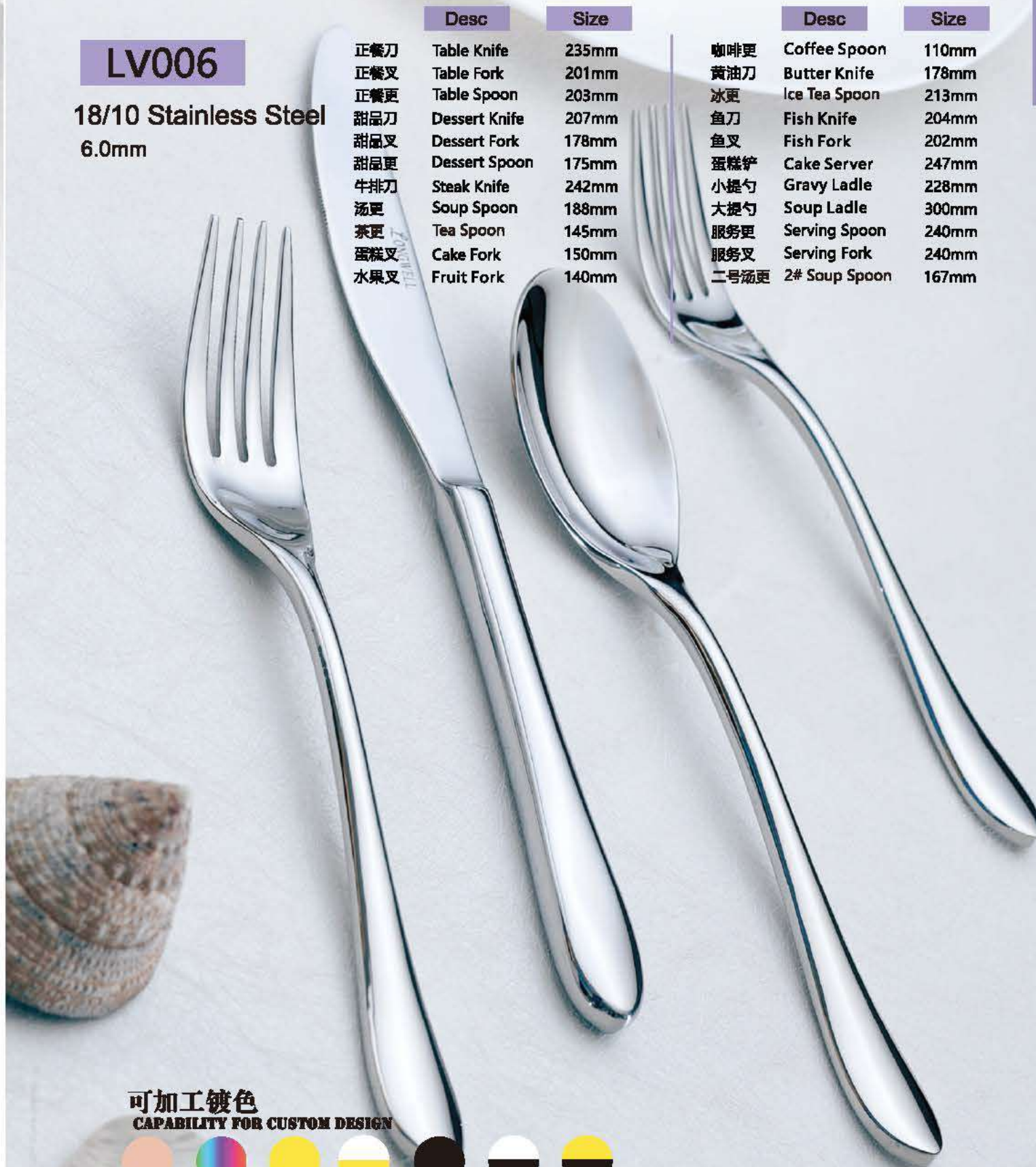

可加工镀色
CAPABILITY FOR CUSTOM DESIGN



PITO®

PITO®

可加工镀色
CAPABILITY FOR CUSTOM DESIGN



玫瑰金 Rose Gold 彩金 Multi-Color Gold 镀金 Gold Plating 半金 Semi Gold 镀黑 Black Coating 半黑 Half Black 黑金 Black And Gold

LV9005

Stainless Steel
3.5mm

Desc	Size
正餐刀	Table Knife 230mm
正餐叉	Table Fork 203mm
正餐更	Table Spoon 203mm
甜品刀	Dessert Knife 213mm
甜品叉	Dessert Fork 185mm
甜品更	Dessert Spoon 185mm
牛排刀	Steak Knife 218mm
汤更	Soup Spoon 175mm
水果叉	Fruit Fork 145mm
蛋糕叉	Cake Fork 136mm

Desc	Size
茶更	Tea Spoon 133mm
冰更	Ice Tea Spoon 206mm
咖啡更	Coffee Spoon 119mm
黄油刀	Butter Knife 146mm
鱼刀	Fish Knife 203mm
鱼叉	Fish Fork 186mm
蛋糕更	Ice Cream Spoon 125mm
服务更	Serving Spoon 241mm
服务叉	Serving Fork 247mm

LV2022

18/10 Stainless Steel
3.5mm * 没有库存 (NO stock)

Desc	Size
正餐刀	Table Knife 235mm
正餐叉	Table Fork 209mm
正餐更	Table Spoon 208mm
甜品刀	Dessert Knife 210mm
甜品叉	Dessert Fork 192mm
甜品更	Dessert Spoon 190mm
牛排刀	Steak Knife 235mm
汤更	Soup Spoon 190mm
水果叉	Fruit Fork 150mm

Desc	Size
茶更	Tea Spoon 150mm
咖啡更	Coffee Spoon 115mm
蛋糕叉*	Cake Fork* 150mm
黄油刀*	Butter Knife* 165mm
冰更*	Ice Tea Spoon* 205mm
鱼刀*	Fish Knife* 190mm
鱼叉*	Fish Fork* 188mm
服务更*	Serving Spoon* 238mm
服务叉*	Serving Fork* 240mm

可加工镀色
CAPABILITY FOR CUSTOM DESIGN

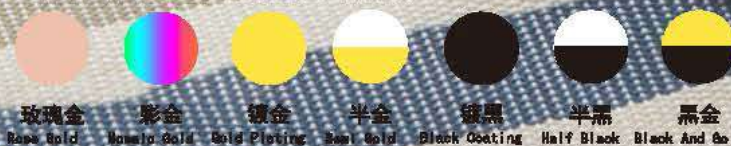

玫瑰金 Rose Gold 彩金 Multi-Color Gold 镀金 Gold Plating 半金 Semi Gold 镀黑 Black Coating 半黑 Half Black 黑金 Black And Gold

LV2003

18/10 Stainless Steel
5.0mm

	Desc	Size
正餐刀	Table Knife	235mm
正餐叉	Table Fork	204mm
正餐更	Table Spoon	203mm
甜品刀	Dessert Knife	212mm
甜品叉	Dessert Fork	182mm
甜品更	Dessert Spoon	185mm
牛排刀	Steak Knife	235mm
蛋糕叉	Cake Fork	144mm
水果叉	Fruit Fork	147mm

	Desc	Size
汤更	Soup Spoon	178mm
咖啡更	Coffee Spoon	118mm
茶更	Tea Spoon	135mm
冰更	Ice Tea Spoon	201mm
鱼刀	Fish Knife	221mm
鱼叉	Fish Fork	204mm
黄油刀	Butter Knife	161mm
服务更	Serving Spoon	233mm
服务叉	Serving Fork	231mm



LV2026

18/10 Stainless Steel
3.5mm

	Desc	Size
正餐刀	Table Knife	243mm
正餐叉	Table Fork	202mm
正餐更	Table Spoon	211mm
甜品刀	Dessert Knife	224mm
甜品叉	Dessert Fork	188mm
甜品更	Dessert Spoon	190mm
牛排刀	Steak Knife	243mm

	Desc	Size
汤更	Soup Spoon	177mm
茶更	Tea Spoon	142mm
咖啡更	Coffee Spoon	114mm
蛋糕叉	Cake Fork	158mm
鱼刀	Fish Knife	208mm
鱼叉	Fish Fork	190mm
黄油刀	Butter Knife	174mm

LV2003

18/10 Stainless Steel
4.0mm

Desc	Size	Desc	Size
正餐刀 Table Knife	244mm	茶更 Tea Spoon	142mm
正餐叉 Table Fork	211mm	咖啡更 Coffee Spoon	114mm
正餐更 Table Spoon	211mm	蛋糕叉 Cake Fork	158mm
甜品刀 Dessert Knife	224mm	黄油刀 Butter Knife	208mm
甜品叉 Dessert Fork	190mm	鱼刀 Fish Knife	204mm
甜品更 Dessert Spoon	190mm	鱼叉 Fish Fork	190mm
汤更 Soup Spoon	179mm		

西餐刀叉

西餐刀叉



LV2012

18/10 Stainless Steel
5.0mm

Desc	Size	Desc	Size
正餐刀 Table Knife	245mm	咖啡更 Coffee Spoon	115mm
正餐叉 Table Fork	212mm	黄油刀 Butter Knife	183mm
正餐更 Table Spoon	214mm	蛋糕叉 Cake Fork	147mm
甜品刀 Dessert Knife	218mm	水果叉 Fruit Fork	147mm
甜品叉 Dessert Fork	193mm	服务更 Serving Spoon	260mm
甜品更 Dessert Spoon	193mm	漏餐更 PCB Spoon	257mm
牛排刀 Steak Knife	245mm	鱼刀 Fish Knife	181mm
汤更 Soup Spoon	184mm	鱼叉 Fish Fork	183mm
茶更 Tea Spoon	147mm		

高贵典雅的造型，轻柔美妙的触感，
让一切变得舒适、自然，昨日的无线荣耀
在您今日的经典时尚。

可加工镀色 CAPABILITY FOR CUSTOM DESIGN



玫瑰金 Rose Gold 彩金 Multi Gold 镀金 Gold Plating 半金 Semi Gold 镀黑 Black Coating 半黑 Half Black 黑金 Black And Gold

PITO®

CN618

18/10 Sainless Steel
5.0mm

	Desc	Size
正餐刀	Table Knife	240mm
正餐叉	Table Fork	210mm
正餐更	Table Spoon	210mm
甜品刀	Dessert Knife	215mm
甜品叉	Dessert Fork	195mm
甜品更	Dessert Spoon	198mm
牛排刀	Steak Knife	239mm
汤更	Soup Spoon	195mm
水果叉	Fruit Fork	145mm
咖啡更	Coffee Spoon	138mm
摩卡更	Mocha Spoon	115mm



PITO®

西餐刀叉



LV2032

18/10 Stainless Steel
5.0mm

	Desc	Size		Desc	Size
正餐刀 (立刀)	Table Knife(Standing Knife)	236mm	咖啡更	Coffee Spoon	120mm
正餐叉	Table Fork	212mm	茶更	Tea Spoon	138mm
正餐更	Table Spoon	210mm	鱼刀	Fish Knife	199mm
甜品刀 (立刀)	Dessert Knife(Standing Knife)	205mm	鱼叉	Fish Fork	182mm
甜品叉	Dessert Fork	190mm	黄油刀	Butter Knife	172mm
甜品更	Dessert Spoon	189mm	服务更	Serving Spoon	228mm
牛排刀 (立刀)	Steak Knife(Standing Knife)	235mm	服务叉	Serving Fork	230mm
汤更	Soup Spoon	193mm			
蛋糕叉	Cake Fork	155mm			
水果叉	Fruit Fork	142mm			

LV2006

18/10 Stainless Steel
4.0mm

Desc	Size	Desc	Size
正餐刀	Table Knife 240mm	汤更	Soup Spoon 188mm
正餐叉	Table Fork 218mm	水果叉	Fruit Fork 115mm
正餐更	Table Spoon 216mm	蛋糕叉	Serving Fork 140mm
甜品刀	Dessert Knife 212mm	冰更	Ice Tea Spoon 220mm
甜品叉	Dessert Fork 192mm	鱼刀	Fish Knife 226mm
甜品更	Dessert Spoon 192mm	鱼叉	Fish Fork 218mm
牛排刀	Steak Knife 237mm	黄油刀	Butter Knife 158mm
茶更	Tea Spoon 135mm	服务更	Serving Spoon 255mm
咖啡更	Coffee Spoon 119mm	服务叉	Serving Fork 253mm

LV2037

18/10 Stainless Steel
4.0mm

Desc	Size	Desc	Size
正餐刀	Table Knife 238mm	茶更	Tea Spoon 145mm
正餐叉	Table Fork 210mm	咖啡更	Coffee Spoon 118mm
正餐更	Table Spoon 210mm	黄油刀	Butter Knife 160mm
甜品刀	Dessert Knife 214mm	汤更	Soup Spoon 178mm
甜品叉	Dessert Fork 188mm	蛋糕叉	Cake Fork 146mm
甜品更	Dessert Spoon 188mm	服务叉	Serving Fork 240mm
牛排刀	Steak Knife 238mm	服务更	Serving Spoon 240mm



PITO®

LV2007

18/10 Stainless Steel
3.0mm

	Desc	Size
正餐刀	Table Knife	240mm
正餐叉	Table Fork	207mm
正餐更	Table Spoon	210mm
甜品刀	Dessert Knife	212mm
甜品叉	Dessert Fork	182mm
甜品更	Dessert Spoon	184mm
茶更	Tea Spoon	139mm
咖啡更	Coffee Spoon	112mm
蛋糕叉	Cake Fork	144mm
汤更	Soup Spoon	177mm
冰更	Ice Tea Spoon	200mm
蛋糕铲	Cake Server	238mm



PITO®

LV2012

18/10 Stainless Steel
4.0mm

	Desc	Size		Desc	Size
正餐刀	Table Knife	223mm	牛排刀	Steak Knife	223mm
正餐叉	Table Fork	204mm	汤更	Soup Spoon	176mm
正餐更	Table Spoon	204mm	茶更	Tea Spoon	144mm
甜品刀	Dessert Knife	204mm	蛋糕叉	Cake Fork	155mm
甜品叉	Dessert Fork	183mm	咖啡更	Coffee Spoon	108mm
甜品更	Dessert Spoon	185mm	黄油刀	Butter Knife	175mm

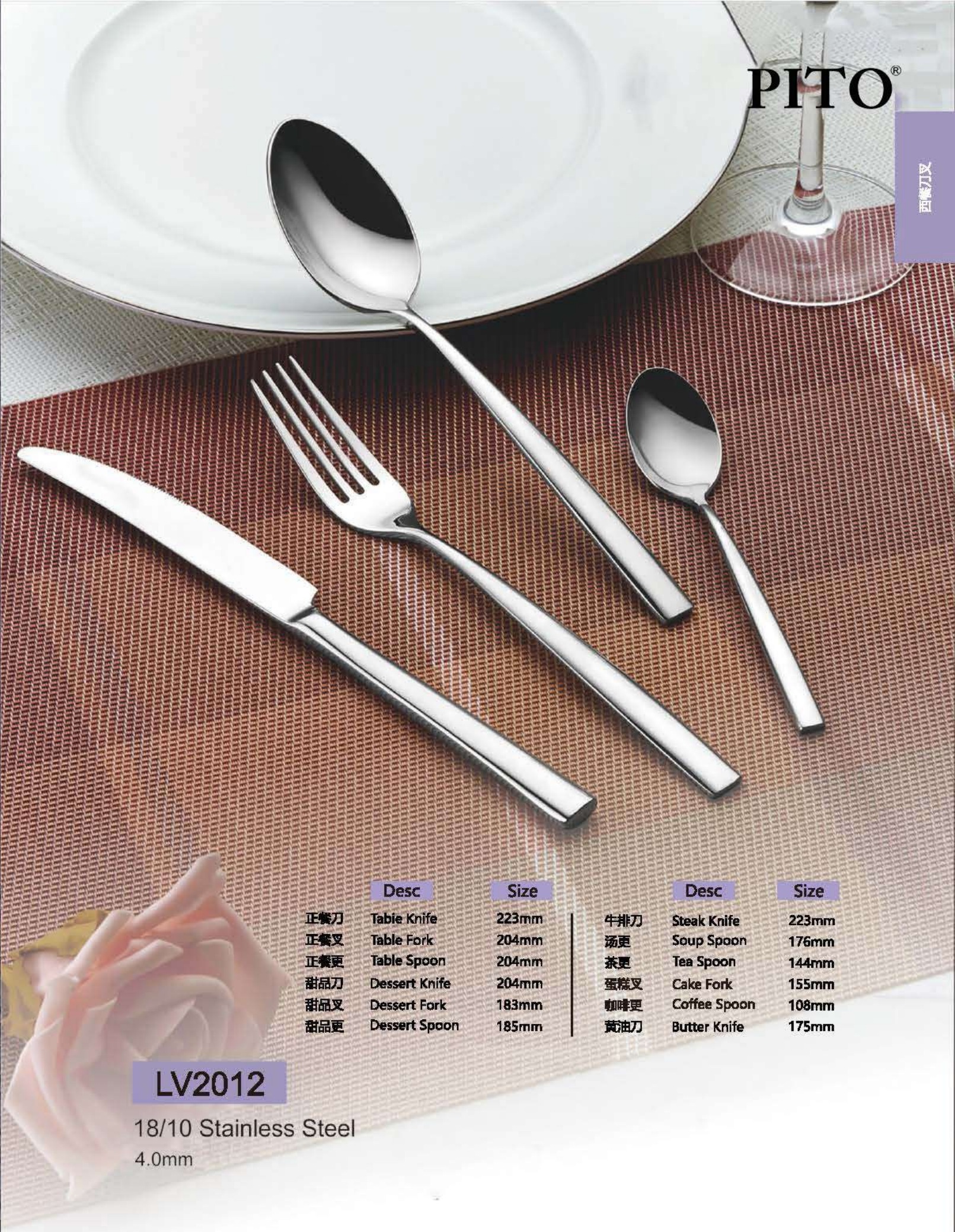

PITO

西餐刀叉

LV2009

18/10 Stainless Steel
3.0mm



Desc	Size	Desc	Size		
正餐刀	Table Knife	225mm	茶更	Tea Spoon	146mm
正餐叉	Table Fork	208mm	咖啡更	Coffee Spoon	112mm
正餐更	Table Spoon	209mm	鱼刀	Fish Knife	203mm
甜品刀	Dessert Knife	209mm	鱼叉	Fish Fork	178mm
甜品叉	Dessert Fork	184mm	蛋糕铲	Cake Server	234mm
甜品更	Dessert Spoon	185mm	沙拉更	Salad Spoon	286mm
牛排刀	Steak Knife	224mm	沙拉叉	Salad Fork	286mm
汤更	Soup Spoon	172mm	大提勺	Soup Ladle	300mm
蛋糕叉	Cake Fork	147mm	服务更	Serving Spoon	243mm

PITO

西餐刀叉

LV2008G

18/10 stainless steel
5.0mm*



LV2008

18/10 Stainless Steel
4.0mm

Desc	Size	
正餐刀	Table Knife	250mm
正餐叉	Table Fork	215mm
正餐更	Table Spoon	218mm
甜品刀	Dessert Knife	228mm
甜品叉	Dessert Fork	191mm
甜品更	Dessert Spoon	194mm
牛排刀	Steak Knife	250mm
黄油刀	Butter Knife	178mm
咖啡更	Coffee Spoon	118mm
蛋糕叉	Cake Fork	152mm
冰更	Ice Tea Spoon	180mm
汤更	Soup Spoon	178mm
茶更	Tea Spoon	144mm
鱼刀	Fish Knife	235mm
鱼叉	Fish Fork	215mm
服务叉	Serving Fork	243mm
服务更	Serving Spoon	246mm



PITO®

PITO®

西餐刀叉

CN318

Stainless Steel
7.0mm

Desc	Size	Desc	Size		
正餐刀	Table Knife	235mm	水果叉	Fruit Fork	140mm
正餐叉	Table Fork	205mm	雪糕更	Ice Cream Spoon	135mm
正餐更	Table Spoon	203mm	冰更	Ice Tea Spoon	210mm
甜品刀	Dessert Knife	205mm	黄油刀	Butter Knie	162mm
甜品叉	Dessert Fork	177mm	蛋糕铲	Cake Server	242mm
甜品更	Dessert Spoon	175mm	鱼刀	Fish Knife	208mm
牛排刀	Steak Knife	235mm	鱼叉	Fish Fork	208mm
汤更	Soup Spoon	190mm	服务更	Serving Spoon	214mm
茶更	Tea Spoon	140mm	服务叉	Serving Fork	216mm
咖啡更	Coffee Spoon	112mm	小提勺	Gravy Ladle	176mm
蛋糕叉	Cake Fork	147mm	大提勺	Soup Ladle	330mm



LV051

Stainless Steel
5.0mm

Desc	Size	Desc	Size		
正餐刀	Table Knife	232mm	汤更	Soup Spoon	201mm
正餐叉	Table Fork	206mm	茶更	Tea Spoon	146mm
正餐更	Table Spoon	209mm	咖啡更	Coffee Spoon	120mm
甜品刀	Dessert Knife	218mm	黄油刀	Butter Knife	151mm
甜品叉	Dessert Fork	183mm	冰更	Ice Tea Spoon	204mm
甜品更	Dessert Spoon	187mm	鱼刀	Fish Knife	227mm
牛排刀	Steak Knife	234mm	鱼叉	Fish Fork	210mm
水果叉	Fruit Fork	142mm	服务叉	Serving Fork	243mm
蛋糕叉	Cake Fork	152mm	服务更	Serving Spoon	246mm



PITO®

西餐刀叉

	Desc	Size
正餐叉	Table Fork	214mm
正餐刀	Table Knife	230mm
正餐更	Table Spoon	215mm
甜品叉	Dessert Fork	182mm
甜品刀	Dessert Knife	198mm
甜品更	Dessert Spoon	174mm
牛排刀	Steak Knife	236mm
汤更	Soup Spoon	199mm
茶更	Tea Spoon	144mm

	Desc	Size
蛋糕叉	Cake Fork	146mm
水果叉	Fruit Fork	117mm
咖啡更	Coffee Spoon	120mm
冰更	Ice Tea Spoon	226mm
黄油刀	Butter Knife	154mm
鱼叉	Fish Fork	183mm
鱼刀	Fish Knife	189mm
服务更	Serving Spoon	246mm
服务叉	Serving Fork	246mm

CN030
Stainless Steel
7.0mm



PITO®

西餐刀叉

	Desc	Size
正餐刀	Table Knife	240mm
正餐叉	Table Fork	203mm
正餐更	Table Spoon	200mm
甜品刀	Dessert Knife	215mm
甜品叉	Dessert Fork	176mm
甜品更	Dessert Spoon	176mm
牛排刀	Steak Knife	245mm
茶更	Tea Spoon	141mm
汤更	Soup Spoon	199mm

	Desc	Size
蛋糕叉	Cake Fork	145mm
水果叉	Fruit Fork	143mm
咖啡更	Coffee Spoon	127mm
黄油刀	Butter Knife	160mm
冰更	Ice Tea Spoon	200mm
鱼刀	Fish Knife	195mm
鱼叉	Fish Fork	188mm
服务更	Serving Spoon	205mm
服务叉	Serving Fork	209mm

LV029
Stainless Steel
5.0mm



LV066

Stainless Steel
4.0mm

	Desc	Size		Desc	Size
正餐刀	Table Knife	242mm	蛋糕叉	Cake Fork	160mm
正餐更	Table Spoon	218mm	冰更	Ice Tea Spoon	200mm
正餐叉	Table Fprk	217mm	雪糕更	Ice Cream Spoon	150mm
甜品刀	Dessert Knife	200mm	黄油刀	Butter Knie	164mm
甜品叉	Dessert Fork	195mm	鱼刀	Fish Knife	235mm
甜品更	Dessert Spoon	214mm	鱼叉	Fish Fork	220mm
牛排刀	Steak Knife	247mm	分菜更	Serving Spoon	218mm
汤更	Soup Spoon	207mm	沙拉更	Salad Spoon	215mm
茶更	Tea Spoon	156mm	沙拉叉	Salad Fork	215mm
咖啡更	Coffee Spoon	121mm	服务叉	Serving Fork	226mm
水果叉	Fruit Fork	162mm	服务更	Serving Spoon	226mm



LV9001

Stainless Steel
5.0mm

	Desc	Size		Desc	Size
正餐刀	Table Knife	240mm	咖啡更	Coffee Spoon	127mm
正餐叉	Table Fork	211mm	蛋糕叉	Cake Fork	155mm
正餐更	Table Spoon	211mm	水果叉	Fruit Fork	153mm
甜品刀	Dessert Knife	210mm	鱼叉	Fish Fork	212mm
甜品叉	Dessert Fork	191mm	鱼刀	Fish Knife	228mm
甜品更	Dessert Spoon	190mm	黄油刀	Butter Knife	161mm
牛排刀	Steak Knife	242mm	冰更	Ice Tea Spoon	203mm
汤更	Soup Spoon	203mm	服务更	Serving Spoon	229mm
茶更	Tea Spoon	152mm	服务叉	Serving Fork	234mm



LV082

Stainless Steel
3.0mm



LV092

Stainless Steel
3.0mm

1#服务更	1#Serving Spoon	250mm
1#服务叉	1#Serving Fork	240mm
小提勺	Gravy Ladle	240mm
2#服务更	2#Serving Spoon	206mm
2#服务叉	2#Serving Fork	213mm
雪糕勺	Ice Cream Spoon	135mm
糖更	Sugar Spoon	129mm

正餐刀	Table Knife	225mm
正餐更	Table Spoon	203mm
正餐叉	Table Fprk	203mm
甜品更	Dessert Spoon	198mm
甜品叉	Dessert Fork	185mm
甜品刀	Dessert Knife	184mm
尖茶更	O.tea Spoon	163mm
圆茶更	R.tea Spoon	150mm
蛋糕叉	Cake Fork	134mm
尖咖啡更	O.coffee Spoon	132mm
圆咖啡更	R.coffee Spoon	121mm
茶叉	Tea Fork	161mm
尖摩卡更	O.mocha Spoon	113mm
圆摩卡更	R.mocha Spoon	106mm
水果叉	Fruit Fork	118mm
糖夹	Sugar Tong	110mm
尖冰更	O.Ice Tea Spoon	185mm
圆冰更	R.Ice Tea Spoon	171mm
1#汤更	1#soup Spoon	190mm
2#汤更	2#soup Spoon	168mm
牛排刀	Steak Knife	221mm
肉叉	Meat Fork	160mm
鱼刀	Fish Knife	208mm
黄油刀	Butter Knie	168mm
沙拉叉	Salad Fork	185mm
沙拉更	Salad Spoon	185mm



LV083

Stainless Steel
3.0mm



	Desc	Size
正餐刀	Table Knife	231mm
正餐叉	Table Fork	201mm
正餐更	Table Spoon	178mm
甜品刀	Dessert Knife	207mm
甜品叉	Dessert Fork	183mm
甜品更	Dessert Spoon	179mm
牛排刀	Steak Knife	232mm
汤更	Soup Spoon	187mm
茶更	Tea Spoon	137mm
咖啡更	coffee Spoon	121mm

	Desc	Size
蛋糕叉	Cake Fork	145mm
水果叉	Fruit Fork	150mm
冰更	Ice Tea Spoon	171mm
鱼刀	Fish Knife	213mm
鱼叉	Fish Fork	204mm
黄油刀	Butter Knife	152mm
分菜更	Serving Spoon	192mm
雪糕勺	Ice Cream Spoon	137mm
沙拉叉	Salad Fork	202mm
沙拉更	Salad Spoon	195mm

PITO®

西餐刀叉



LV2002

18/10 Stainless Steel
5.0mm



	Desc	Size
正餐刀	Table Knife	238mm
正餐叉	Table Fork	198mm
正餐更	Table Spoon	200mm
茶更	Tea Spoon	152mm
茶叉	Tea Fork	152mm

PITO®

西餐刀叉



LV9004

18/10 Stainless Steel
15mm

LV2038

18/10 Stainless Steel
4.0mm

正餐刀	Table Knife	238mm
正餐叉	Table Fork	210mm
正餐更	Table Spoon	210mm
甜品刀	Dessert Knife	214mm
甜品叉	Dessert Fork	188mm
甜品更	Dessert Spoon	188mm
牛排刀	Steak Knife	238mm
汤更	Soup Spoon	178mm
蛋糕叉	Cake Fork	146mm
茶更	Tea Spoon	145mm
咖啡更	Coffee Spoon	118mm
黄油刀	Butter Knife	160mm
服务叉	Serving Fork	240mm
服务更	Serving Spoon	240mm



PITO®

PITO®

西餐刀叉

西餐刀叉



LV2101

18/0 Stainless Steel

10.0mm

Desc	Size
牛排刀	Steak Knife 223mm
牛排叉	Steak Fork 221mm
汤更	Soup Spoon 221mm

- 专业切牛排餐具。
- 采用4Cr13钢材，刀刃比普通刀锋利4倍。
- 实心铸件，让产品的手感得到更深层次的升华。
- 进口红彩木，回归原野生活，赏心悦目。



LV2102

18/10 Stainless Steel

10.0mm

Desc	Size
牛排刀	Steak Knife 223mm
牛排叉	Steak Fork 221mm
汤更	Soup Spoon 221mm

- 专业切牛排餐具。
- 采用4Cr13钢材，刀刃比普通刀锋利4倍。
- 实心铸件，让产品的手感得到更深层次的升华。
- 进口斑马木，与不锈钢结合，使生活绚丽多彩。

PITO®

西餐刀叉

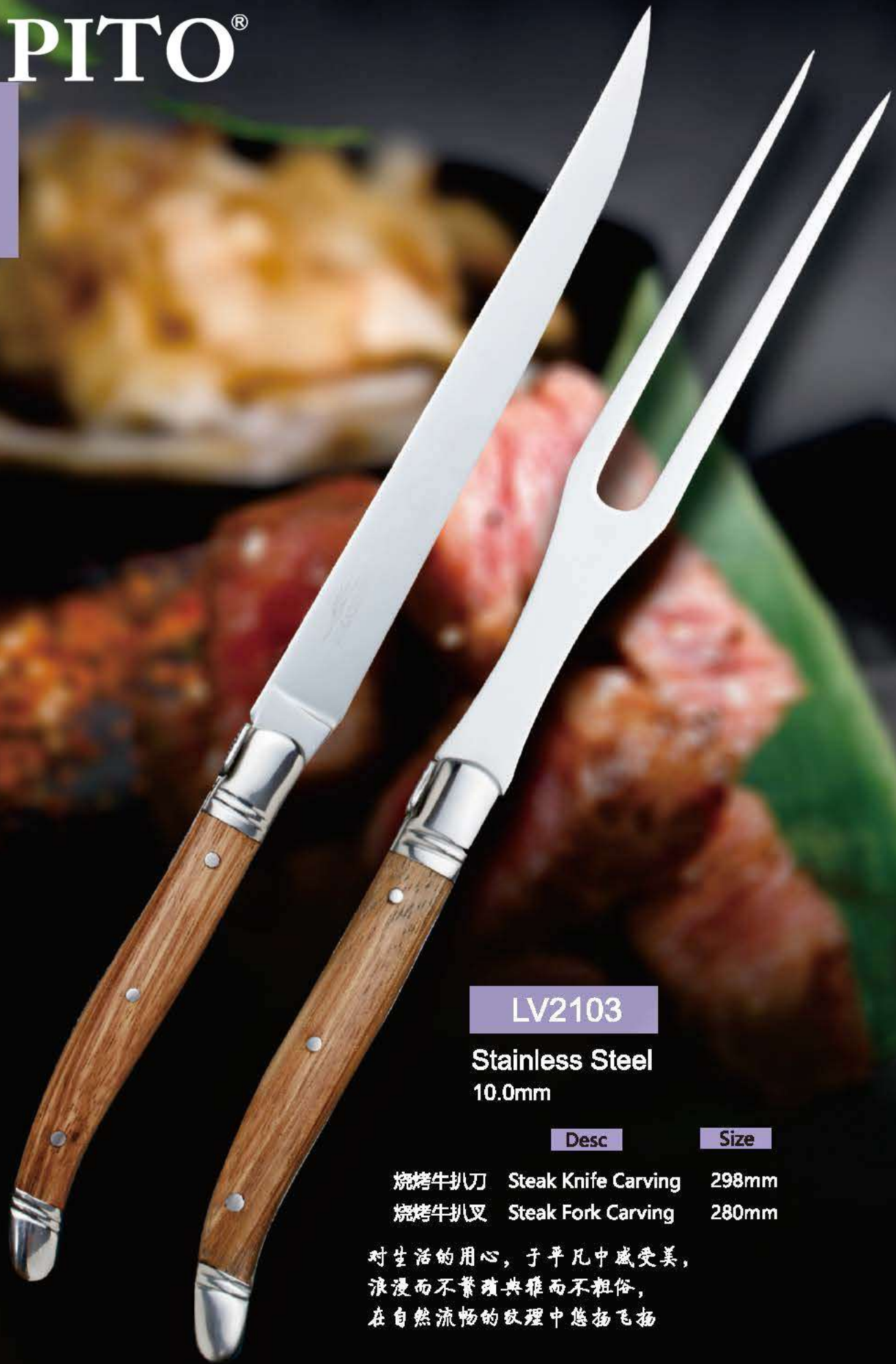

LV2103
Stainless Steel
10.0mm

Desc	Size
烧烤牛扒刀 Steak Knife Carving	298mm
烧烤牛扒叉 Steak Fork Carving	280mm

对生活的用心，于平凡中感受美，
浪漫而不繁缛典雅而不粗俗，
在自然流畅的纹理中悠扬飞扬

PITO®

西餐刀叉



LV9008
Stainless Steel
Sun Angel

Desc	Size
正餐刀 Table Knife	170mm
正餐叉 Table Fork	137mm
正餐更 Table Spoon	154mm



PITO®

PITO®

西餐刀叉

西餐刀叉

LV9009

18/10 Stainless Steel
3.0mm 可定制图案

You Can Laser Engraving The Cartoon Pattern You Want

正餐刀	Table Knife	170mm
正餐叉	Table Fork	155mm
正餐更	Table Spoon	155mm
茶更	Tae Spoon	130mm



LV9010

18/10 Stainless Steel
3.0mm

Desc	Size
正餐刀	180mm
正餐叉	165mm
正餐更	165mm



PITO®

LV006BS

18/10 Stainless Steel
5.0mm

	Desc	Size
正餐刀	Table Knife	235mm
正餐叉	Table Fork	201mm
正餐更	Table Spoon	203mm
甜品刀	Dessert Knife	207mm
甜品叉	Dessert Fork	178mm
甜品更	Dessert Spoon	175mm
牛排刀	Steak Knife	242mm
汤更	Soup Spoon	188mm
茶更	Tea Spoon	145mm
蛋糕叉	Cake Fork	150mm
水果叉	Fruit Fork	140mm

	Desc	Size
咖啡更	Coffee Spoon	110mm
黄油刀	Butter Knife	178mm
冰更	Ice Tea Spoon	213mm
鱼刀	Fish Knife	204mm
鱼叉	Fish Fork	202mm
蛋糕铲	Cake Server	247mm
小提勺	Gravy Ladle	228mm
大提勺	Soup Ladle	300mm
服务更	Serving Spoon	240mm
服务叉	Serving Fork	240mm
二号汤更	2# Soup Spoon	167mm



PITO®



LV2003G

18/10 Stainless Steel
4.0mm

	Desc	Size
正餐刀	Table Knife	244mm
正餐叉	Table Fork	211mm
正餐更	Table Spoon	211mm
甜品刀	Dessert Knife	224mm
甜品叉	Dessert Fork	190mm
甜品更	Dessert Spoon	190mm
汤更	Soup Spoon	179mm

	Desc	Size
茶更	Tea Spoon	142mm
咖啡更	Coffee Spoon	114mm
蛋糕叉	Cake Fork	158mm
黄油刀	Butter Knife	208mm
鱼刀	Fish Knife	204mm
鱼叉	Fish Fork	190mm

PITO®

西餐刀叉



LV2022B

18/10 Stainless Steel
3.5mm * 没有库存 (NO stock)

Desc	Size	Desc	Size		
正餐刀	Table Knife	235mm	茶更	Tea Spoon	150mm
正餐叉	Table Fork	209mm	咖啡更	Coffee Spoon	115mm
正餐更	Table Spoon	208mm	蛋糕叉*	Cake Fork*	150mm
甜品刀	Dessert Knife	210mm	黄油刀*	Butter Knife*	165mm
甜品叉	Dessert Fork	192mm	冰更*	Ice Tea Spoon*	205mm
甜品更	Dessert Spoon	190mm	鱼刀*	Fish Knife*	190mm
牛排刀	Steak Knife	235mm	鱼叉*	Fish Fork*	188mm
汤更	Soup Soon	190mm	服务更*	Serving Spoon*	238mm
水果叉	Fruit Fork	150mm	服务叉*	Serving Fork*	240mm

PITO®

西餐刀叉



LV2022R

18/10 Stainless Steel
3.5mm * 没有库存 (NO stock)

Desc	Size	
正餐刀	Table Knife	235mm
正餐叉	Table Fork	209mm
正餐更	Table Spoon	208mm
甜品刀	Dessert Knife	210mm
甜品叉	Dessert Fork	192mm
甜品更	Dessert Spoon	190mm
牛排刀	Steak Knife	235mm
汤更	Soup Soon	190mm
水果叉	Fruit Fork	150mm
茶更	Tea Spoon	150mm
咖啡更	Coffee Spoon	115mm
蛋糕叉*	Cake Fork*	150mm
黄油刀*	Butter Knife*	165mm
冰更*	Ice Tea Spoon*	205mm
鱼刀*	Fish Knife*	190mm
鱼叉*	Fish Fork*	188mm
服务更*	Serving Spoon*	238mm
服务叉*	Serving Fork*	240mm

LV2022G

18/10 stainless steel
3.5mm 规格参照LV2022R





LV9005B

Stainless Steel
3.5mm

Desc	Size
正餐刀	Table Knife 230mm
正餐叉	Table Fork 203mm
正餐更	Table Spoon 203mm
甜品刀	Dessert Knife 213mm
甜品叉	Dessert Fork 185mm
甜品更	Dessert Spoon 185mm
牛排刀	Steak Knife 218mm
汤更	Soup Spoon 175mm
水果叉	Fruit Fork 145mm
蛋糕叉	Cake Fork 136mm

Desc	Size
茶更	Tea Spoon 133mm
冰更	Ice Tea Spoon 206mm
咖啡更	Coffee Spoon 119mm
黄油刀	Butter Knife 146mm
鱼刀	Fish Knife 203mm
鱼叉	Fish Fork 186mm
雪糕更	Ice Cream Spoon 125mm
服务更	Serving Spoon 241mm
服务叉	Serving Fork 247mm



LV9005G

Stainless Steel
3.5mm

Desc	Size
正餐刀	Table Knife 230mm
正餐叉	Table Fork 203mm
正餐更	Table Spoon 203mm
甜品刀	Dessert Knife 213mm
甜品叉	Dessert Fork 185mm
甜品更	Dessert Spoon 185mm
牛排刀	Steak Knife 218mm
汤更	Soup Spoon 175mm
水果叉	Fruit Fork 145mm
蛋糕叉	Cake Fork 136mm

Desc	Size
茶更	Tea Spoon 133mm
冰更	Ice Tea Spoon 206mm
咖啡更	Coffee Spoon 119mm
黄油刀	Butter Knife 146mm
鱼刀	Fish Knife 203mm
鱼叉	Fish Fork 186mm
雪糕更	Ice Cream Spoon 125mm
服务更	Serving Spoon 241mm
服务叉	Serving Fork 247mm

PITO®

PITO®

西餐刀叉



LV2012BG

18/10 Stainless Steel
5.0mm

The modelling of elegant soft tactility,
beautiful make all comfortable,natural,yesterday's glory,
wireless in your gets today's classical fashion.



LV2012G

18/10 Stainless Steel
5.0mm

Desc	Size
正餐刀	Table Knife 245mm
正餐叉	Table Fork 212mm
正餐更	Table Spoon 214mm
甜品刀	Dessert Knife 218mm
甜品叉	Dessert Fork 193mm
甜品更	Dessert Spoon 193mm
牛排刀	Steak Knife 245mm
汤更	Soup Spoon 184mm
茶更	Tea Spoon 147mm

Desc	Size
咖啡更	Coffee Spoon 115mm
黄油刀	Butter Knife 183mm
蛋糕叉	Cake Fork 147mm
水果叉	Fruit Fork 147mm
服务更	Serving Spoon 260mm
漏餐更	PCB Spoon 257mm
鱼刀	Fish Knife 181mm
鱼叉	Fish Fork 183mm

LV2204

18/10 Stainless Steel
6.0mm

	Desc	Size
正餐刀	Table Knife	210mm
正餐叉	Table Fork	197mm
正餐更	Table Spoon	196mm
蛋糕叉	Cake Fork	143mm
茶更	Tea Spoon	146mm
黄油刀	Butter Knife	159mm

LV2012GT

18/10 Stainless Steel
5.0mm

Desc	Size	Desc	Size		
正餐刀	Table Knife	245mm	咖啡更	Coffee Spoon	115mm
正餐叉	Table Fork	212mm	黄油刀	Butter Knife	183mm
正餐更	Table Spoon	214mm	蛋糕叉	Cake Fork	147mm
甜品刀	Dessert Knife	218mm	水果叉	Fruit Fork	147mm
甜品叉	Dessert Fork	193mm	服务更	Serving Spoon	260mm
甜品更	Dessert Spoon	193mm	漏餐更	PCB Spoon	257mm
牛排刀	Steak Knife	245mm	鱼刀	Fish Knife	181mm
汤更	Soup Spoon	184mm	鱼叉	Fish Fork	183mm
茶更	Tea Spoon	147mm			



PITO®

西餐刀叉



LV2205PG

18/10 Stainless Steel
6.0mm

	Desc	Size
正餐刀	Table Knife	218mm
正餐叉	Table Fork	219mm
正餐更	Table Spoon	212mm
茶更	Tea Spoon	121mm

PITO®

西餐刀叉



	Desc	Size
正餐刀	Table Knife	218mm
正餐叉	Table Fork	219mm
正餐更	Table Spoon	212mm
茶更	Tea Spoon	121mm

PITO®

西餐刀叉



LV2202

18/10 Stainless Steel
6.0mm

Desc	Size	Desc	Size		
正餐刀	Table Knife	225mm	茶更	Tea Spoon	147mm
正餐叉	Table Fork	198mm	咖啡更	Coffee Spoon	134mm
正餐更	Table Spoon	195mm	蛋糕叉	Cake Fork	144mm
甜品刀	Dessert Knife	203mm	水果叉	Fruit Fork	203mm
甜品叉	Dessert Fork	183mm	冰更	Ice Tea Spoon	143mm
甜品更	Dessert Spoon	181mm	筷子	Chopsticks	235mm
牛排刀	Steak Knife	223mm	黄油刀	Butter Knife	162mm

PITO®

西餐刀叉



LV2202BS

18/10 Stainless Steel
6.0mm

Desc	Size	Desc	Size		
正餐刀	Table Knife	222mm	茶更	Tea Spoon	147mm
正餐叉	Table Fork	198mm	咖啡更	Coffee Spoon	134mm
正餐更	Table Spoon	195mm	蛋糕叉	Cake Fork	144mm
甜品刀	Dessert Knife	203mm	水果叉	Fruit Fork	203mm
甜品叉	Dessert Fork	183mm	冰更	Ice Tea Spoon	143mm
甜品更	Dessert Spoon	181mm	筷子	Chopsticks	235mm
牛排刀	Steak Knife	223mm	黄油刀	Butter Knife	162mm

LV2201

18/10 Stainless Steel

4.0mm

Desc	Size	Desc	Size
正餐刀	Table Knife 221mm	茶更	Tea Spoon 126mm
正餐叉	Table Fork 217mm	蛋糕叉	Cake Fork 125mm
正餐更	Table Spoon 211mm	冰更	Ice Tea Spoon 195mm
甜品刀	Dessert Knife 200mm		
甜品更	Dessert Spoon 180mm		
甜品叉	Dessert Fork 180mm		

可加工镀色
Capability for custom design



LV2201BS

18/10 Stainless Steel

4.0mm

Desc	Size
正餐刀	Table Knife 221mm
正餐叉	Table Fork 217mm
正餐更	Table Spoon 211mm
甜品刀	Dessert Knife 200mm
甜品更	Dessert Spoon 180mm
甜品叉	Dessert Fork 180mm
茶更	Tea Spoon 126mm
蛋糕叉	Cake Fork 125mm
冰更	Ice Tea Spoon 195mm

PITO®

西餐刀叉



LV2201BG

18/10 Stainless Steel
4.0mm

	Desc	Size
正餐刀	Table Knife	221mm
正餐叉	Table Fork	217mm
正餐更	Table Spoon	211mm
甜品刀	Dessert Knife	200mm
甜品更	Dessert Spoon	180mm
甜品叉	Dessert Fork	180mm
茶更	Tea Spoon	126mm
蛋糕叉	Cake Fork	125mm
冰更	Ice Tea Spoon	195mm

LV2201EG

18/10 Stainless Steel
4.0mm



西餐刀叉

LV2201B

18/10 Stainless Steel
4.0mm



LV2201WG

18/10 Stainless Steel
4.0mm



LV2201G

18/10 Stainless Steel
4.0mm

西餐刀叉

西餐刀叉



LV2022MC

18/10 Stainless Steel
3.5mm

Desc	Size
正餐刀	Table Knife 235mm
正餐叉	Table Fork 209mm
正餐更	Table Spoon 208mm
甜品刀	Dessert Knife 210mm
甜品叉	Dessert Fork 192mm
甜品更	Dessert Spoon 190mm
牛排刀	Steak Knife 235mm
汤更	Soup Spoon 190mm
水果叉	Fruit Fork 150mm

Desc	Size
茶更	Tea Spoon 150mm
咖啡更	Coffee Spoon 115mm
蛋糕叉*	Cake Fork* 150mm
黄油刀*	Butter Knife* 165mm
冰更*	Ice Tea Spoon* 205mm
鱼刀*	Fish Knife* 190mm
鱼叉*	Fish Fork* 188mm
服务更*	Serving Spoon* 238mm
服务叉*	Serving Fork* 240mm



LV2206MC

18/10 Stainless Steel
6.0mm

Desc	Size
正餐刀	Table Knife 230mm
正餐叉	Table Fork 205mm
正餐更	Table Spoon 205mm
茶更	Tea Spoon 150mm

轻复古

轻复古，传达了朴素美学的概念，
希望能将生活的细节与品味融为一体
将审美艺术融入物品中，展现真实的生活状态，
Flocafol更加注重轻复古的使用设计。

每一件都是手工制作和打磨。
经过十多个复杂的过程，
展示自然、精致的产品，
呈现古典美



CN118J

Stainless Steel
6.0mm

	Desc	Size		Desc	Size
正餐刀	Table Knife	233mm	雪糕更	Ice Cream Spoon	163mm
正餐叉	Table Fork	201mm	摩卡更	Mocha Spoon	112mm
正餐更	Table Spoon	198mm	冰更	Ice Tea Spoon	190mm
甜品刀	Dessert Knife	203mm	黄油刀	Butter Knife	180mm
甜品叉	Dessert Fork	172mm	鱼刀	Fish Knife	195mm
甜品更	Dessert Spoon	174mm	鱼叉	Fish Fork	193mm
牛排刀	Steak Knife	227mm	小提勺	Gravy Ladle	180mm
汤更	Soup Spoon	185mm	大提勺	Soup Ladle	320mm
蛋糕叉	Cake Fork	144mm	服务更	Serving Spoon	220mm
水果叉	Fruit Fork	136mm	服务叉	Serving Fork	220mm
咖啡更	Coffee Spoon	138mm			

PITO®

PITO®

西餐刀叉

LV2003J

18/10 Stainless Steel
4mm

Desc	Size
正餐刀	Table Knife 244mm
正餐叉	Table Fork 211mm
正餐更	Table Spoon 211mm
甜品刀	Dessert Knife 224mm
甜品叉	Dessert Fork 190mm
甜品更	Dessert Spoon 190mm
汤更	Soup Spoon 179mm

Desc	Size
茶更	Tea Spoon 142mm
咖啡更	Coffee Spoon 114mm
蛋糕叉	Cake Fork 158mm
黄油刀	Butter Knife 208mm
鱼叉	Fish Fork 190mm
鱼刀	Fish Knife 204mm

LV2012J

18/10 Stainless Steel
5.0mm

Desc	Size	Desc	Size
正餐刀	Table Knife 245mm	咖啡更	Coffee Spoon 115mm
正餐叉	Table Fork 212mm	黄油刀	Butter Knife 183mm
正餐更	Table Spoon 214mm	蛋糕叉	Cake Fork 147mm
甜品刀	Dessert Knife 218mm	水果叉	Fruit Fork 147mm
甜品叉	Dessert Fork 193mm	服务更	Serving Spoon 260mm
甜品更	Dessert Spoon 193mm	漏餐更	PCB Spoon 257mm
牛排刀	Steak Knife 245mm	鱼刀	Fish Knife 181mm
汤更	Soup Spoon 184mm	鱼叉	Fish Fork 183mm
茶更	Tea Spoon 147mm		

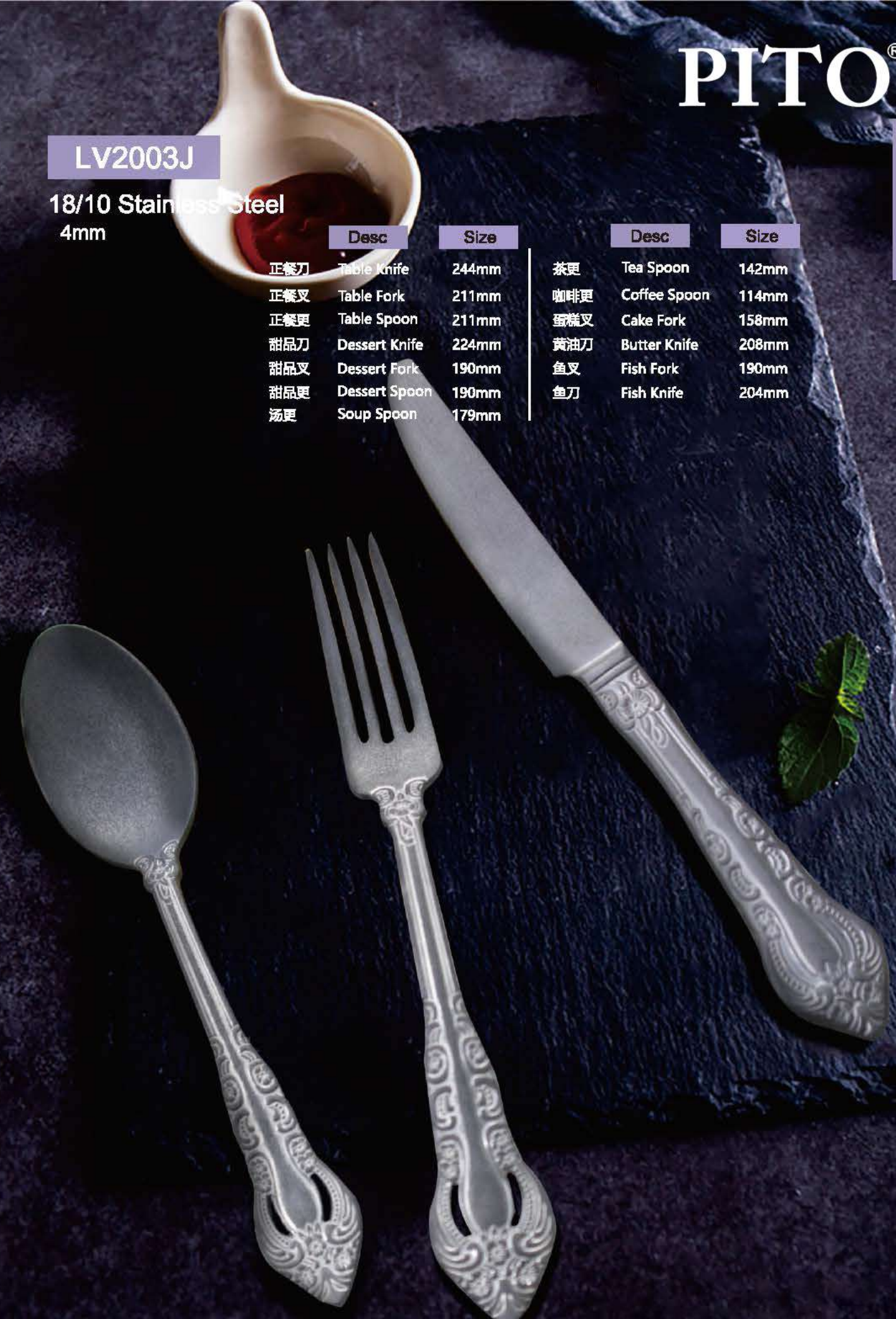

西餐刀叉

PITO®

PITO®

LV096-1

18/10 Stainless Steel
5.0mm

	Desc	Size
正餐刀	Table Knife	236mm
正餐叉	Table Fork	207mm
正餐更	Table Spoon	210mm
甜品刀	Dessert Knife	241mm
甜品叉	Dessert Spoon	195mm
甜品更	Dessert Fork	190mm
牛排刀	Steak Knife	237mm
汤更	Soup Spoon	195mm

	Desc	Size
茶更	Tea Spoon	145mm
咖啡更	Coffee Spoon	115mm
蛋糕叉	Cake Fork	120mm
水果叉	Fruit Fork	115mm
黄油刀	Butter Knife	175mm
服务更	Serving Spoon	211mm



LV2203

18/10 Stainless Steel
6.5mm

	Desc	Size
正餐刀	Table Knife	230mm
正餐叉	Table Fork	220mm
正餐更	Table Spoon	220mm
茶更	Tea Spoon	150mm

西餐刀叉

西餐刀叉

LV096

10/0Stainless Steel
5.0mm



Desc	Size
正餐刀	Table Knife 228mm
正餐叉	Table Fork 206mm
正餐更	Table Spoon 205mm
甜品刀	Dessert Knife 210mm
甜品叉	Dessert Spoon 190mm
甜品更	Dessert Fork 191mm
牛排刀	Steak Knife 228mm
汤更#1	Tea Spoon#1 188mm
汤更#2	Tea Spoon#2 176mm
茶叉	Tea Fork 160mm

Desc	Size
水果叉	Fruit Fork 123mm
尖茶更	O.Tea Spoon 157mm
圆茶更	R.Tea Spoon 153mm
尖咖啡更	O.Coffee Spoon 136mm
圆咖啡更	R.Coffee Spoon 130mm
蛋糕叉	Cake Fork 138mm
尖摩卡更	O.mocha Spoon 115mm
圆摩卡更	R.mocha Spoon 110mm
尖冰更	O.Ice Tea Spoon 181mm
圆冰更	R.Ice Tea Spoon 175mm



MC086

Stainless Steel
3.0mm

Desc	Size
正餐刀	Table Knife 240mm
正餐叉	Table Fork 205mm
正餐更	Table Spoon 203mm
甜品刀	Dessert Knife 212mm
甜品叉	Dessert Fork 189mm
甜品更	Dessert Spoon 190mm
牛排刀	Steak Knife 238mm
汤更	Soup Spoon 185mm
水果叉	Fruit Fork 121mm

Desc	Size
圆茶更	R.tea Spoon 151mm
糖夹	Sugar Tong 110mm
冰更	Ice Tea Spoon 190mm
鱼刀	Fish Knife 210mm
鱼叉	Fish Fork 205mm
肉叉	Meat Fork 162mm
小提勺	Gravy Ladle 203mm
大提勺	Soup Ladle 295mm
服务更	Serving Spoon 210mm
蛋糕铲	Cake Server 220mm

PITO®

PITO®

西餐刀叉

西餐刀叉



LV098

Stainless Steel
3.0mm

	Desc	Size
正餐刀	Table Knife	232mm
正餐叉	Table Fork	210mm
正餐更	Table Spoon	202mm
甜品刀	Dessert Knife	218mm
甜品叉	Dessert Fork	195mm
甜品更	Dessert Spoon	195mm
牛排刀	Steak Knife	231mm
汤更#1	Soup Spoon#1	196mm
汤更#2	Soup Spoon#2	186mm
茶更	Tea Spoon	146mm
茶叉	Tea Fork	155mm
肉叉	Meat Fork	150mm

	Desc	Size
冰更#1	Ice Tea Spoon#1	198mm
冰更#2	Ice Tea Spoon#2	172mm
咖啡更#1	Coffee Spoon#1	133mm
咖啡更#2	Coffee Spoon#2	128mm
蛋糕叉	Cake Fork	136mm
莫卡更#1	Mocha Spon#1	115mm
莫卡更#2	Mocha Spon#2	110mm
水果叉	Fruit Fork	125mm
黄油刀	Butter Knife	153mm
雪糕更	Ice Cream Spoon	136mm
服务更	Serving Spoon	215mm

LV095

18/0 Stainless Steel
3.0mm

	Desc	Size
正餐刀	Table Knife	228mm
正餐叉	Table Fork	206mm
正餐更	Table Spoon	205mm
甜品刀	Dessert Knife	209mm
甜品叉	Dessert Fork	188mm
甜品更	Dessert Spoon	188mm
牛排刀	Steak Knife	227mm
汤更#1	Soup Spoon#1	192mm
汤更#2	Soup Spoon#2	176mm
茶叉	Tea Fork	161mm

	Desc	Size
尖茶更	O.Tea Spoon	153mm
圆茶更	R.Tea Spoon	150mm
水果叉	Fruit Fork	120mm
蛋糕叉	Cake Fork	134mm
尖咖啡更	O.Coffee Spoon	133mm
圆咖啡更	R.Coffee Spoon	127mm
尖摩卡更	O.Mocha Spoon	113mm
圆摩卡更	R.Mocha Spoon	110mm
尖冰更	O.Ice Tea Spoon	180mm
圆冰更	R.Ice Tea Spoon	173mm



PITO®

PITO®

西餐刀叉

西餐刀叉



LV099

18/10 Stainless Steel
3.0mm

Desc	Size
正餐刀	Table Knife 230mm
正餐叉	Table Fork 200mm
甜品刀	Dessert Knife 210mm
甜品叉	Dessert Fork 183mm
甜品更	Dessert Spoon 183mm
牛排刀	Steak Knife 230mm
汤更#1	1#Soup Spoon 182mm
汤更#2	2#Soup Spoon 175mm
蛋糕叉	Cake Fork 152mm
茶更	Tea Spoon 153mm
咖啡更	Coffee Spoon 133mm
摩卡更	Mocha Spoon 110mm

Desc	Size
水果叉	Fruit Fork 158mm
糖更	Sugar Spoon 145mm
0冰更	0.Ice Tea Spoon 195mm
0冰更	0.Ice Tea Spoon 205mm
黄油刀	Butter Knife 163mm
鱼刀	Fish Knife 198mm
鱼叉	Fish Fork 192mm
蛋糕铲	Cake Server 213mm
服务更	Serving Spoon 193mm
服务叉	Serving Fork 196mm
沙拉叉	Salad Fork 221mm
沙拉更	Salad Spoon 221mm
小提勺	Gravy Ladle 176mm

LV081

Stainless Steel
2.5mm

Desc	Size
正餐刀	Table Knife 245mm
正餐叉	Table Fork 215mm
正餐更	Table Spoon 205mm
甜品刀	Dessert Knife 227mm
甜品叉	Dessert Fork 185mm
甜品更	Dessert Spoon 180mm
牛排刀	Steak Knife 235mm
汤更	Soup Spoon 188mm
茶更	Tea Spoon 142mm
咖啡更	Coffee Spoon 111mm
蛋糕叉	Cake Fork 148mm

Desc	Size
水果叉	Fruit Fork 150mm
冰更	Ice Tea Spoon 131mm
黄油刀	Butter Knife 151mm
鱼刀	Fish Knife 217mm
鱼叉	Fish Fork 204mm
雪糕勺	Ice Cream Spoom 136mm
糖更	Sugar Spoon 134mm
服务更	Serving Spoon 205mm
沙拉叉	Salad Fork 212mm
沙拉更	Salad Spoon 212mm



Composition of cutlery set in gift.box packing

ITEMS	16PCS	20PCS	24PCS	30PCS	36PCS	68PCS	72PCS	84PCS	101PCS	113PCS	130PCS
DINNER KNIFE	4	4	6	6	6	12	12	12	12	12	12
DESSERT KNIFE									12	12	12
DINNER SPOON	4	4	6	6	6	12	12	12	12	12	12
DESSERT SPOON									12		12
TEA SPOON	4	4	6	6	6	12	12	12	12	12	12
MOCCA SPOON									12	12	12
DINNER FORK	4	4	6	6	6	12	12	12	12	12	12
DESSERT FORK									12	12	12
CAKE FORK		4		6	6	12	12	12			
FISH FORK										12	12
FISH KNIFE										12	12
CREAM SPOON						1	1	1	1		
SUGAR SPOON					1	1	1	1	1		1
SALAD FORK					1		1	1	1		1
SALAD SPOON					1		1	1	1		1
VEGETABLE SPOON					1	2	2	2		1	1
MEAT FORK						2	2	2			
CAKE SERVE							1	1			
SUFAR TONG						1	1	1			
GRAVY LADLE					1	1	1	1	1	1	1
SOUP LADLE					1		1	1		1	1
CRAVING FORK											1
SERVING FISH FORK										1	1
SERVING FISH KNIFE										1	1
CEAVING KNIFE											1

LV2026G

18/10 Stainless Steel
3.5mm

Desc	Size	Desc	Size
正餐刀 Table Knife	243mm	汤更 Soup Spoon	177mm
正餐叉 Table Fork	202mm	茶更 Tea Spoon	142mm
正餐更 Table Spoon	211mm	咖啡更 Coffee Spoon	114mm
甜品刀 Dessert Knife	224mm	蛋糕叉 Cake Fork	158mm
甜品叉 Dessert Fork	188mm	鱼刀 Fish Knife	208mm
甜品更 Dessert Spoon	190mm	鱼叉 Fish Fork	190mm
牛排刀 Steak Knife	243mm	黄油刀 Butter Knife	174mm

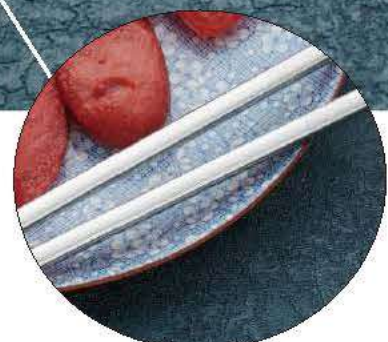

LV6001 Stainless Steel
尺寸(Size) 230mm

隔热、耐热、耐高温、耐磨
Heat Insulation, Heat Resistance, High Temperature Resistance, Wear Resistance

在筷子末端加入螺旋设计，增加筷子与食物的摩擦更方便使用
Add Spiral Design To The End Of The Chopsticks, Increase The Friction Of Chopsticks And Food More Convenient To Use

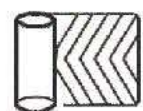

上面方，下面圆，光滑防滑
Square Above, Round Below, Smooth And Non-slip



耐高温
High Temperature Resistant



容易清洁
Easy To Clean



食品级不锈钢
Food Grade Stainless Steel



18/10 Stainless Steel

LV6002 方形空心筷
尺寸(Size) 230mm

LV6003 圆形空心筷
尺寸(Size) 230mm

LV6004 青花瓷柄空心筷
尺寸(Size) 230mm

LV6005 韩式实心方筷
尺寸(Size) 230mm

LV6006 不锈钢空心儿童筷
尺寸(Size) 180mm



上面方，下面圆，光滑防滑



耐高温



容易清洁



食品级不锈钢

PITO®

PITO®

西餐刀叉

西餐刀叉

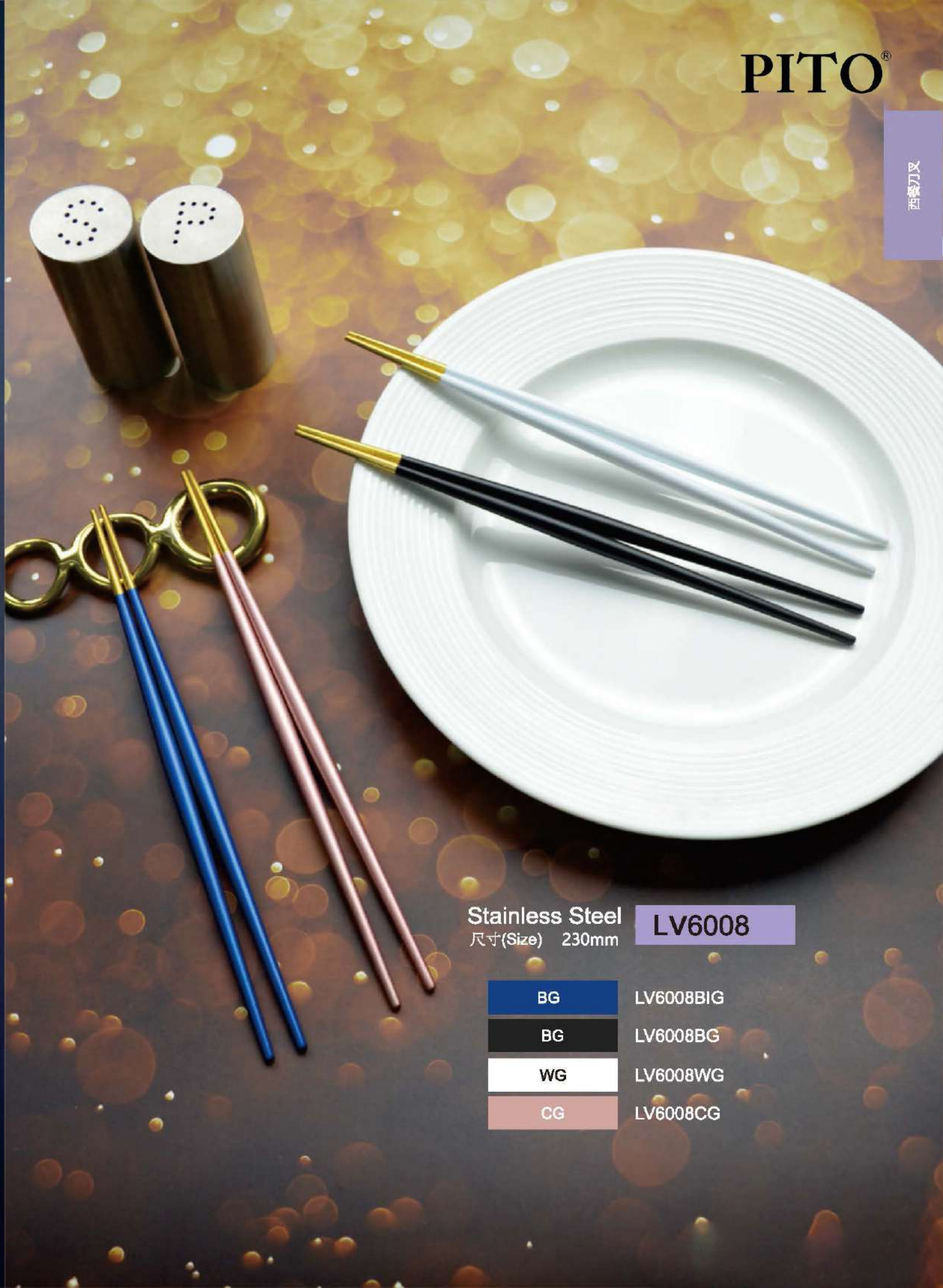

LV6002

不锈钢
Stainless Steel
尺寸(Size) 230mm

BIG	LV6002BIG
BG	LV6002BG
WG	LV6002WG
CG	LV6002CG
PG	LV6002PG

Stainless Steel
尺寸(Size) 230mm

LV6008

BG	LV6008BIG
BG	LV6008BG
WG	LV6008WG
CG	LV6008CG

LV6009-1 直的 Straight
尺寸(Size) 21.5mm

LV6009-2 弯曲 Bending
尺寸(Size) 20.5mm

18/10 Stainless Steel

西餐刀叉

西餐刀叉



FC-004

18/10 Stainless Steel

咖啡更
Coffee Spoon
统一大小:125mm
Uniform size:125mm

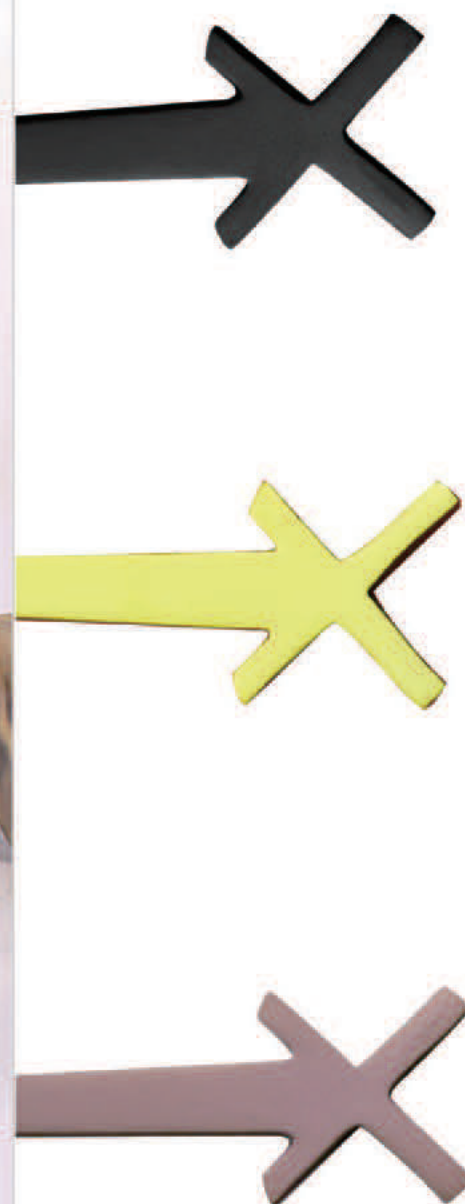
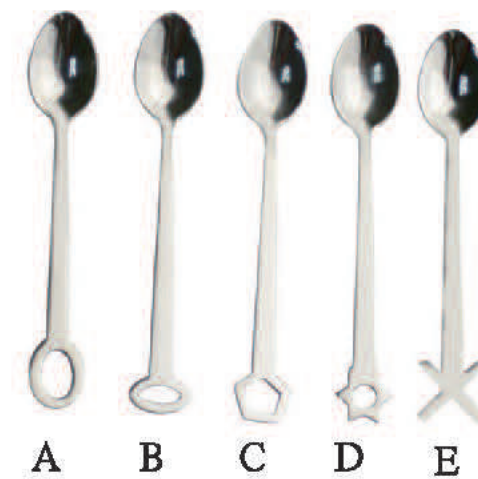



FC-056

- 蓝色钻石柄甜品叉 180mm
Blue Diamond Handle Dessert Fork
- 蓝色钻石柄甜品更 180mm
Blue Diamond Handle Dessert Spoon
- 蓝色钻石柄茶叉 158mm
Blue Diamond Handle Tea Fork
- 蓝色钻石柄茶勺 158mm
Blue Diamond Handle Tea Spoon



FC-057

- 红色钻石柄冰更 220mm
Red Diamond Handle Ice Spoon
- 红色钻石柄茶更 180mm
Red Diamond Handle Tea Spoon
- 红色钻石柄茶叉 180mm
Red Diamond Handle Tea Fork
- 红色钻石柄水果叉 158mm
Red Diamond Handle Fruit Fork



FC-058

- 白色钻石柄甜品叉 180mm
White Diamond Handle Dessert Fork
- 白色钻石柄甜品更 180mm
White Diamond Handle Dessert Spoon
- 白色钻石柄茶叉 158mm
White Diamond Handle Tea Fork
- 白色钻石柄茶勺 158mm
White Diamond Handle Tea Spoon
- 白色钻石柄水果叉 158mm
White Diamond Handle Fruit Fork



- 咖啡更**
Coffee Spoon
编号(Code) 尺寸(Size)
FC-006CS 15.5cm



- 双头咖啡勺**
Double Head Spoon
编号(Code) 尺寸(Size)
FC-007MS 19.5cm



- 咖啡更**
Coffee Spoon
编号(Code) 品名(Desc) 尺寸(Size)
FC-013CS 勺(Spoon) 134mm
FC-013IF 叉(Fork) 137mm



- 甜品叉勺**
Pastry Flatware
编号(Code) 品名(Desc) 尺寸(Size)
FC-022ES 勺(Spoon) 135mm
FC-022CF 叉(Fork) 135mm



- Coffee Spoon**
编号(Code) 尺寸(Size)
FC-005CS 98mm
FC-005ES 126mm
FC-005-1CS 147mm
FC-005-2CS 150mm



- 儿童叉勺** 多种图案可选
Pastry Flatware
编号(Code) 品名(Desc) 尺寸(Size)
FC-014ES 勺(Spoon) 143mm
FC-014CF 叉(Fork) 143mm



- 甜品叉勺**
Pastry Flatware Set
编号(Code) 品名(Desc) 尺寸(Size)
LV2201ES 勺(Spoon) 125mm
LV2201CF 叉(Fork) 125mm



- 甜品叉勺**
Pastry Flatware Set
编号(Code) 品名(Desc) 尺寸(Size)
LV2202BA-ES 勺(Spoon) 144mm
LV2202BA-CF 叉(Fork) 147mm



- 甜品叉勺**
Pastry Flatware
编号(Code) 品名(Desc) 尺寸(Size)
LV9005ES 勺(Spoon) 135mm
LV9005CF 叉(Fork) 136mm



- 甜品叉勺**
Pastry Flatware
编号(Code) 品名(Desc) 尺寸(Size)
MC022-C-ES 勺(Spoon) 148mm
MC022-C-CF 叉(Fork) 147mm



- 甜品叉勺**
Steak Fork And Knife
编号(Code) 品名(Desc)
FC-010A 刀(Knife)
FC-010B 叉(Fork)



- 牛排叉刀**
Steak Fork And Knife
编号(Code) 品名(Desc) 尺寸(Size)
FC-008A 勺(Knife) 205mm
FC-008B 叉(Fork) 195mm



- 牛排叉刀**
Steak Fork And Knife
编号(Code) 品名(Desc) 尺寸(Size)
FC-009A 刀(Knife) 205mm
FC-009B 叉(Fork) 195mm



- 汤匙**
Soup Spoon
编号(Code) 尺寸(Size)
FC-013SS(S) 13.3cmX3.5cm
FC-013SS(M) 14.5cmX4.0cm
FC-013SS(L) 16.2cmX4.3cm



- 汤匙**
Soup Spoon
编号(Code) 尺寸(Size)
FC-014SS(S) 13.3cmX3.5cm
FC-014SS(M) 14.5cmX4.0cm
FC-014SS(L) 16.2cmX4.3cm



弯柄勺
Happy Flatware
编号(Code) 尺寸(Size)
FC-012DS 122mm
FC-012DF 122mm
FC-012SS 120mm



沙拉/服务 套装
Salad/buffet Serving Set
编号(Code) 品名(Desc) 尺寸(Size)
LV092RS 勺(Spoon) 27.8cm
LV092RF 叉(Fork) 27.8cm



沙拉/服务 套装
Salad/buffet Serving Set
编号(Code) 品名(Desc) 尺寸(Size)
LV006RS 勺(Spoon) 24cm
LV006RF 叉(Fork) 24cm



沙拉/服务 套装
Salad/buffet Serving Set
编号(Code) 品名(Desc) 尺寸(Size)
LV9006RS 勺(Spoon) 24.1cm
LV9006RF 叉(Fork) 24.7cm



蛋糕刀
long cake knife
编号(Code) 尺寸(Size)
C1515RK 28.5cm



弯柄勺
Happy Flatware
编号(Code) 尺寸(Size)
FC-012(M)DS 122mm
FC-012(M)DF 122mm
FC-012(M)SS 120mm



沙拉/服务 套装
Salad/buffet Serving Set
编号(Code) 品名(Desc) 尺寸(Size)
LV2006RS 勺(Spoon) 25cm
LV2006RF 叉(Fork) 25cm



沙拉/服务 套装
Salad/buffet Serving Set
编号(Code) 品名(Desc) 尺寸(Size)
MC022-C-RS勺(Spoon) 21.4cm
MC022-C-RF叉(Fork) 21.4cm



沙拉/服务 勺
Salad/buffet Serving Set
编号(Code) 尺寸(Size)
C91200A 27.5cmX9cm
C91200B 27.5cmX9cm
C91200C 27.8cmX9cm
C91200D 27.5cmX9cm



蛋糕铲
Buffet serving spoon
编号(Code) 尺寸(Size)
A LV006CR 250mmX53mm
B MC022CFH 255mmX48mm
C MC022-C-CFH 255mmX48mm



沙拉/服务 套装
Salad/buffet Serving Set
编号(Code) 品名(Desc) 尺寸(Size)
LV1010RS 勺(Spoon) 19.8cmX7cm
LV1010RF 叉(Fork) 19.8cmX7cm



沙拉/服务 套装
Salad/buffet Serving Set
编号(Code) 品名(Desc) 尺寸(Size)
CN118RS 勺(Spoon) 220mm
CN118RF 叉(Fork) 220mm



沙拉/服务 套装
Salad/buffet Serving Set
编号(Code) 品名(Desc) 尺寸(Size)
MC022RS 勺(Spoon) 21.4cm
MC022RF 叉(Fork) 21.4cm



沙拉/服务 勺
Salad/buffet Serving Set
编号(Code) 尺寸(Size)
C90126 245mm
C90127 245mm
C90128A 270mm
C90128B 335mm
C90129 335mm



酒吧长柄匙
Bar Spoon
编号(Code) 尺寸(Size)
FC-015BS 260mm
FC-015BF 261mm

高质量汤勺 18/10 stainless steel

细节决定质量，就像美味的汤需要时间煮一样，LANGWELL选择了高质量的勺子和30多个工序，每一个工序都经过精心制作，呈现在你眼前最完美的过程



汤勺/汁勺
Soup Ladle
编号(Code) 尺寸(Size)
MC022SL 280mm
MC022GL 185mm



304款火锅勺
Hot Pot Tools
编号(Code) 尺寸(Size)
C90140-S 27.5cmX7.3cm
C90140-L 27.5cmX7.3cm



火锅勺
Hot Pot Tools
编号(Code) 尺寸(Size) 编号(Code) 尺寸(Size)
C90113-6S 19cmX6cm C90113-7L 22cmX7cm
C90113-6L 19cmX6cm C90113-8S 25cmX8cm
C90113-7S 22cmX7cm C90113-8L 25cmX8cm



汤勺/汁勺
Soup Ladle
编号(Code) 尺寸(Size)
LV006SL 320mm
LV006GL 230mm



汤勺/汁勺
Soup Ladle
编号(Code) 尺寸(Size)
CN118SL 320mm
CN118GL 180mm



火锅勺
Hot Pot Tools
编号(Code) 尺寸(Size)
C90103-6S 19cmX6cm
C90103-6L 22cmX6cm
C90103-7S 22cmX6cm
C90103-7L 28cmX7cm



304天鹅火锅勺
Hot Pot Tools
编号(Code) 尺寸(Size)
C90139-S 25.5cmX7.6cm
C90139-L 25.5cmX7.6cm



汤勺/汁勺
Soup Ladle
编号(Code) 尺寸(Size)
MC022-C-SL 280mm
MC022-C-GL 185mm



火锅勺
Hot Pot Tools
编号(Code) 尺寸(Size)
C90104-7S 25cmX7cm
C90104-7L 25cmX7cm

PITO®



火锅勺 Hot Pot Tools

编号(Code)	尺寸(Size)
C90109-6S	21cmX6cm
C90109-6L	21cmX6cm
C90109-7S	28cmX7cm
C90109-7L	28cmX7cm

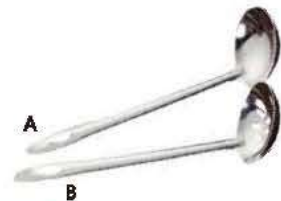

火锅勺 Hot Pot Tools

编号(Code)	尺寸(Size)
C90107-6A	23cmX6cm
C90107-6B	26cmX8cm
C90107-7A	23cmX8cm
C90107-7B	25cmX8cm



勺架 Spoon Stand

编号(Code)	尺寸(Size)
C1506	270mmx115mmx30mm

火锅工具

厨师工具 chef's tools



38.5cm	35cm	35cm	37cm	28cm	34cm	38cm	36cm
C90137MF	C90137TA	C90137PS	C90137PM	C90137SM	C90137PB	C90137PA	C90137LA

厨师工具 chef's tools

编号(Code)	尺寸(Size)	编号(Code)	尺寸(Size)
C90138-1	3.5x23cm	C90138-9	8x26.5cm
C90138-2	4.1x23cm	C90138-10	9.5x28cm
C90138-3	4.9x23cm	C90138-11	10.5x29cm
C90138-4	5.4x23cm	C90138-12	11.5x30cm
C90138-5	5.8x23cm	C90138-13	13x30cm
C90138-6	6.5x26cm		
C90138-7	7x26cm		
C90138-8	7.4x25.5cm		



编号(Code)	尺寸(Size)	编号(Code)	尺寸(Size)
C1501	9.5cmX17.5cm	C1503	10cmX21cm
C1502	10cmX18cm	C1504	10cmX21cm

编号(Code)	尺寸(Size)
C1505	12cmX18cm



编号(Code)	尺寸(Size)
C1507	18.5X15.5X19.5cm

PITO®

优质食品夹

为了享受美味的食物，你需要一个好的食品夹，
炫朗精选剪辑提供给你高质量的食物夹享受美味的食物



编号(Code)	尺寸(Size)
C1039A	1.5mm 22.8cm



编号(Code)	尺寸(Size)
C1039B	1.5mm 22.8cm



编号(Code)	尺寸(Size)
C1039-1	22.5cm



编号(Code)	尺寸(Size)
C1040	10inches



编号(Code)	尺寸(Size)
C1041	12inches



编号(Code)	尺寸(Size)
C1042	11.5inches



沙拉/自助餐夹

Salad/buffet Serving Tongs
 编号(Code) 尺寸(Size)
 C1027-9 6"
 C1027-12 12"



面包夹

Bread Tongs
 编号(Code) 尺寸(Size)
 C1043-9 24cm
 C1043-11 28cm



沙拉/自助餐夹

Salad/buffet Serving Tongs
 编号(Code) 尺寸(Size)
 C1044 10inches



沙拉/自助餐夹

Salad/buffet Serving Set
 编号(Code) 尺寸(Size)
 C1008 9inches



食品夹

Food Tongs
 编号(Code) 尺寸(Size)
 C1037-9 9inches
 C1037-12 12inches
 C1037-16 16inches

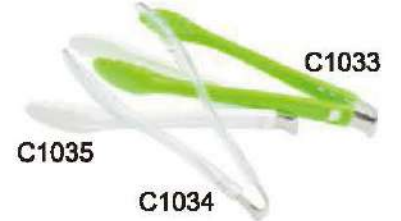

面包夹(透明)

Bread Tongs(transparent)
 编号(Code) 尺寸(Size) 编号(Code) 尺寸(Size)
 C1033-9 9" C1034-10 10"
 C1033-10 10" C1034-11 11"
 C1033-11 11" C1034-12 12"
 C1034-9 9" C1035-10 10"



牛排夹

Steak Tongs
 编号(Code) 尺寸(Size) 品名(Desc)
 C1028 26cm
 C1028-1 28cm 304



沙拉/自助餐夹

Salad/buffet Serving Tongs
 编号(Code) 尺寸(Size)
 C1026-8 8"
 C1026-10 10"
 C1026-12 12"



带锁的牛排夹

Steak Tongs With Lock
 编号(Code) 尺寸(Size)
 C1045-9 9"
 C1045-12 12"



面包夹

Bread Tongs
 编号(Code) 尺寸(Size) 编号(Code) 尺寸(Size)
 C1016A 9inches C1016D 9inches
 C1016B 9inches C1016E 9inches
 C1016C 9inches C1016F 9inches

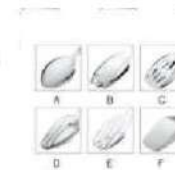

糕点夹

Pastry Tongs
 编号(Code) 尺寸(Size)
 C1013 18cmx7.5cmx3.5cm



肉球夹

Ball Food Tongs
 编号(Code) 尺寸(Size)
 C1021A φ34×160mm
 C1021B φ40×165mm
 C1021C φ44×170mm
 C1021D φ50×175mm



面包夹

Bread Tongs
 编号(Code) 尺寸(Size)
 C1047 240mm



龙虾夹

Lobster Tongs
 编号(Code) 尺寸(Size) 编号(Code) 尺寸(Size)
 C1032-6 6" C1032-8 8"
 C1032-7 7" C1032-9 9"
 C1032-10 10"



食品夹

Food Tongs
 编号(Code) 尺寸(Size) 编号(Code) 尺寸(Size)
 C1031-4 4" C1031-9 9"
 C1031-6 6" C1031-10 10"
 C1031-7 7" C1031-12 12"



冰淇淋勺

Ice Cream Spoon
 编号(Code) 尺寸(Size)
 C1049A 18cm
 C1049B 18cm



冰淇淋勺

Ice Cream Spoon
 编号(Code) 尺寸(Size)
 C1048-1 φ4.5cm
 C1048-2 φ5cm
 C1048-3 φ6cm



鸡蛋夹

Egg Tongs
 编号(Code) 尺寸(Size)
 C1046 18.2cmx6cmx4cm



沙拉/自助餐夹

Salad/buffet Serving Tongs
 编号(Code) 尺寸(Size)
 C1006A 9inches
 C1005B 9inches
 C1006C 9inches

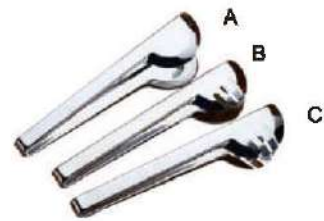

沙拉/自助餐夹

Salad/buffet Serving Tongs
 编号(Code) 尺寸(Size)
 C1004A 9inches
 C1004B 9inches
 C1004C 9inches



带孔食物夹

Food Tongs With Hole
 编号(Code) 尺寸(Size)
 C1002-8 9"
 C1002-7 7"
 C1002-5 5"



糕点夹

Pastry Tongs
 编号(Code) 尺寸(Size)
 C1012B 8"
 C1012C 8"



冰夹

Ice Tongs
 编号(Code) 尺寸(Size)
 C1003-6 6"
 C1003-7 7"
 C1003-8 8"



冰夹

Ice Tongs
 编号 尺寸(Size)
 C1052-6 6"
 C1052-7 7"
 C1052-8 8"
 C1052-9 9"



冰夹
Ice Tongs
编号(Code) 尺寸(Size)
C1053-6 6"
C1053-7 7"
C1053-8 8"
C1053-9 9"



冰夹
Ice Tongs
编号(Code) 尺寸(Size)
C1054 18.2cmx6cmx4cm



糖夹
Sugar Tongs
编号(Code) 尺寸(Size)
C1009 10.8cm



切面刀
Cut Knife
编号(Code) 尺寸(Size)
C26005 15cmx12cmx2.5cm



开罐器
Can opener
编号(Code)
FC-065K



广口开屏器
Jar Opener
编号(Code)
FC-065M



糖夹
Sugar Tongs
编号(Code) 尺寸(Size)
C1010 10cm



台布夹
Tablecloth Tongs
编号(Code) 尺寸(Size)
C1057 6.5CMX4.5CMX2.0CM



蜗牛夹
Snail Tweezer
编号(Code) 尺寸(Size)
C1038 15.5cm



开罐器
Bottle Opener
编号(Code)
FC-065F



果勺
Melon Baller
编号(Code)
FC-065B



开罐器
Opener
编号(Code)
FC-065D



蟹肉夹
crab tongs
编号(Code) 尺寸(Size)
C1056 12cm



鱼骨夹
Hair clips
编号(Code) 尺寸(Size)
C1055 12cm



鱼刷
Fish Sizer Brush
编号(Code) 尺寸(Size)
C26001 19.5cmx3.5cm



压蒜器
Garlic press
编号(Code) 尺寸(Size)
FC-065L 19cmX2.3cm



半自动打蛋器
S/S Whisk
编号(Code) 尺寸(Size)
C26007 30.5CMX6.5CMX6.5CM



油刷
S/S Oil Brush
编号(Code) 尺寸(Size)
C26008-1 19.8cm
C26008-2 30.5cm



防割手挡板
Anti-cutting hand baffle
编号(Code) 尺寸(Size)
C26002 8.5cmx6cmx2.5cm



削皮器
Vegetable Peeler
编号(Code) 尺寸(Size)
C26003 11.3cm



防烫夹
Spoon holder
编号(Code) 尺寸(Size)
C26004 20.5cm



披萨铲
Pie Cake Server
编号(Code)
FC-65J



披萨刀
Pizza Catter
编号(Code) 尺寸(Size)
FC-065I 673x220mm



冰激凌勺
Ice Cream Scoop
编号(Code)
FC-065E



煎蛋器
Egg Rings Non Stick
编号(Code) 尺寸(Size) 圆
C26009 20CMX9CM 8.3cmx1.9cm



切蛋器
Egg Slicer
编号(Code) 尺寸(Size)
C26010 15.3cmx8cmx2.5cm

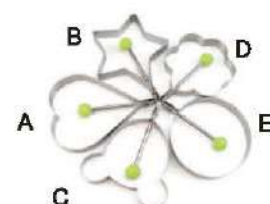

多变形煎蛋器
Stainless Steel egg rings
编号(Code)
C26011



削皮刀
Vegetable PeeLER
编号(Code)
FC-065A



去芯器
Core Remover Tool
编号(Code) 尺寸(Size)
FC-065G 20cmX2cm



奶酪刀
Cheese Knife
编号(Code) 尺寸(Size)
FC-065H 23cmX2cm

PITO®

厨房工具

不锈钢/钛合金制造

专业厨房工具

PITO®



不锈钢片柄量匙
Measuring Spoons
编号(Code) 尺寸(Size)
C26012 Stp 1/4
Stp 1/2
Tsp 1
Tbsp 1/2
Tbsp 1
Tbsp 1 1/2



不锈钢线柄量匙
Measuring Spoons
编号(Code) 尺寸(Size)
C26013 1/4 Tsp
1/2tsp
1 Tsp
1 Tbsp



量匙
Measuring Spoons
编号(Code)
C26014



量匙
Measuring Spoons
编号(Code) 尺寸(Size)
C26015 1 tbsp = 15ml
1 tsp = 5ml
1/2 tsp = 2.5ml
1/4 tsp = 1.25ml
1/8 tsp = 0.6ml



5件套方柄量匙 (A款) 抛光
Measuring Spoons
编号(Code) 尺寸(Size)
C26016 15ml 1
7.5ml 1/2
5ml 1
2.5ml 1/2
TABLESPOON 1/4



4件套量匙 (INOX标记)
Measuring Spoons
编号(Code) 尺寸(Size)
C26017 15ml
5ml
2.5ml 1/2
1.25ml 1/4



4件套量杯
Measuring Spoons
编号(Code) 尺寸(Size)
C26018 60ml cup 1/4
80ml cup 1/3
125ml cup 1/2
250ml cup 1



不锈钢七个装量杯
Measuring Spoons
编号(Code) 尺寸(Size)
C26019 2 Tablespoon 30ml
1 1/2tablespoon 22.5ml
1 Tablespoon 15ml
2 Teaspoon 10ml
1 Teaspoon 5ml
1/2 Tablespoon 2.5ml
1/4 Tablespoon 1.25ml
1/8 Tablespoon 0.625ml



不锈钢胶柄量匙
Measuring Spoons
编号(Code) 尺寸(Size)
C26020 1tbsp
1 Tsp
1/2 Tsp
1/4 Tsp



分蛋器
Egg Separator
编号(Code) 尺寸(Size)
C26021 17cm



304不锈钢实心肉锤
Meat hammer
编号(Code) 尺寸(Size)
C26022 21cmx5.8cmx5cm



餐铃
kitchen bell
编号(Code) 尺寸(Size)
C26023 10cmx7cm



全不锈钢海鲜钳
lobster-crack
编号(Code) 尺寸(Size)
C25036 17.5cmX3.5cm



全钢蟹钳
Crab tools
编号(Code) 尺寸(Size)
C25016 16cmX3.5cm



塑料柄蟹钳
Crab tools
编号(Code) 尺寸(Size)
C25014 16cmX4cm



橡胶蟹钳
Crab tools
编号(Code) 尺寸
C25021 16.5cmX3.5cm



全钢蟹钳
Crab tools
编号(Code) 尺寸(Size)
C25024 16cmX3.5cm



合金蟹钳
Crab tools
编号(Code) 尺寸(Size)
C25038 17cmX3.5cm



蟹具两件套
Seafood Tools Set
编号(Code) 尺寸(Size)
C25017A 17cmX8cm
C25017B 15.6cmX1.6cm

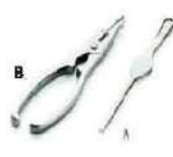

蟹具两件套
Seafood Tools Set
编号(Code) 尺寸(Size)
C25013A 17.5cmX1.5cm
C25013B 18cmX4cm



蟹针
Seafood Fork
编号(Code)
C25039



蟹针
Seafood Fork
编号(Code)
C25040



彩柄小型鸡骨剪
Kitchen Scissors
编号(Code)
C25034



全钢不锈钢鸡骨剪
Kitchen Scissors
编号(Code)
C25035

PITO®



定时器
Kitchen Timer
编号(Code) 尺寸(Size)
C26024 88mmx25mm



定时器
Kitchen Timer
编号(Code) 尺寸(Size)
C26025 72X7X26mm



温度计
Meat Thermometer
编号(Code) 尺寸(Size)
C26026 25.4cm



炸鸡篮
The Fried chicken basket
编号(Code) 尺寸(Size)
C26027 102mmx85mmx65mm



炸鸡篮
The Fried chicken basket
编号(Code) 尺寸(Size)
C26028 85mmx100mmx125mm



炸鸡篮
The Fried chicken basket
编号(Code) 尺寸(Size)
C26029 70mmx80mmx100mm



炸鸡篮
The Fried chicken basket
编号(Code) 尺寸(Size)
C26030 89mmx98mm



炸鸡篮
The Fried chicken basket
编号(Code) 尺寸(Size)
C26031 102mmx83mmx76mm



炸鸡篮
The Fried chicken basket
编号(Code) 尺寸(Size)
C26032 127mmx127mmx87mm



炸鸡篮
The Fried chicken basket
编号(Code) 尺寸(Size)
C26033 200mmx120mmx80mm



炸鸡篮
The Fried chicken basket
编号(Code) 尺寸(Size)
C26034 67mmx90mm



炸鸡篮
The Fried chicken basket
编号(Code) 尺寸(Size)
C26035 102mmx86mmx65mm



炸鸡篮
The Fried chicken basket
编号(Code) 尺寸(Size)
C26036 210mmx100mmx60



炸鸡篮
The Fried chicken basket
编号(Code) 尺寸(Size)
C26037 150mmx150mmx35mm



炸鸡篮
The Fried chicken basket
编号(Code) 尺寸(Size)
C26038 240mmx120mmx35mm

PITO® 桌面用品

精致的餐具不仅可以提高酒店或餐厅的档次
还可以增加顾客的食欲。

炫朗为您精选精美餐具





筷子托
Chopstick Set
编号(Code)
C1305



筷子托
Chopstick Set
编号(Code)
C1304



筷子托
Chopstick Set
编号(Code)
C1306



全金4cm钻石巾圈
Napkin Ring
编号(Code)
LS29319



点心盘
Table Towel Tray
编号(Code) 尺寸(Size)
C1603-1 18.6x9.3mm
C1603-1 23.2x10.3mm
C1603G-1 18.6x9.3mm
C1603G-2 23.2x10.3mm



毛巾碟
Serving Tray
编号(Code) 尺寸(Size)
C1601 2.5mmX 10X14



筷子托
Chopstick Set
编号(Code)
C1307



筷子托
Chopstick Set
编号(Code)
C1308



筷子托
Chopstick Set
编号(Code)
C1303



毛巾碟
Table towel tray
编号(Code) 尺寸(Size)
C1602 15cmX2.5cmX6cm



方形纸巾座
Able Paper Rack
编号(Code) 尺寸(Size)
C1516-1 165x170x110cm
C1516-2 220x190x110cm



钟型纸巾座
Able Paper Rack
编号(Code) 尺寸(Size)
C1517-1 135x138x130cm
C1517-2 170x170x170cm



全金弹弓餐巾圈
Gold Napkin Ring
编号(Code)
LS29310



全银弹弓餐巾圈
Napkin Ring
编号(Code)
LS29311



全银六珠弹弓餐巾圈
Napkin Ring
编号(Code)
LS29312



餐巾架
Serving Tray
编号(Code) 尺寸(Size)
C1508 15cmX2.5cmX6cm
C1509 15cmX2.5cmX6cm



月亮形纸巾夹
Table Paper Rack
编号(Code) 尺寸(Size)
C1518 147x30x81cm



月亮形纸巾夹
Table Towel Tray
编号(Code) 尺寸(Size)
C1519 147x30x81cm



螺旋叉形全银餐巾圈
Napkin Ring
编号(Code)
LS29313



全银方格通花
Napkin Ring
编号(Code)
LS29314



两头金批花金圈
Napkin Ring
编号(Code)
LS29315



牛油碟
Able Paper Rack
编号(Code) 尺寸(Size)
C1604 18.5cmx12.2cmx6.8cm



餐巾架
Table Paper Rack
编号(Code) 尺寸(Size)
C1510 15cmx2.5cmx6cm



树皮纹肥皂碟
Soap Tray
编号(Code) 尺寸(Size)
C1513 10cmX10cm



全银玫瑰巾圈
Gold napkin ring
编号(Code)
LS29318



全银通花福祿喜
Napkin Ring
编号(Code)
LS29317



全金指环镶钻雄鹿
Napkin Ring
编号(Code)
LS29317



树皮纹花瓶
The Vase
编号(Code) 尺寸(Size)
C1514 20cmX5cm



树皮纹纸巾盒
Tissue Box
编号(Code) 尺寸(Size)
C1511 12.5cmX11cm



树皮纹毛巾碟
Table Towel Tray
编号(Code) 尺寸(Size)
C1512 25cmX15cm

PITO®

台号牌

为您整理出不锈钢台号牌
酒店餐桌牌
饭店菜单插卡牌
自助餐桌卡架
号码餐牌



PITO®



方形斜边实心台座
Card Holder
编号(Code) 尺寸(Size)
LS29022 2.5X2.5X2.5cm



方形实心台座
Card Holder
编号(Code) 尺寸(Size)
LS29023 2.5X2.5X2.5cm



三角形台座
Card Holder
编号(Code) 尺寸(Size)
LS29024 7x5.5x7cm



斜面方形实心台座
Card Holder
编号(Code) 尺寸(Size)
LS29025 25x25x34mm
LS29026 25x25x55mm



大长方形实心台座
Card Holder
编号(Code) 尺寸(Size)
LS29028 100x30mm



月牙弯筷子底座
Chopstick Stand
编号(Code) 尺寸(Size)
LS29027 5.5x1.5cm



斜面圆柱实心台座
Card Holder
编号(Code) 尺寸(Size)
LS29012 φ3XH5.3cm



平面圆柱实心台座
Card Holder
编号(Code) 尺寸(Size)
LS29013 3.6X2.5X2.2cm



半圆实心台座
Card Holder
编号(Code) 尺寸(Size)
LS29015 4X2.5X1.25cm
LS29016 6X3X1.5cm



大长方形实心台座
Card Holder
编号(Code) 尺寸(Size)
LS29017 4x3x2cm



半圆实心台座
Card Holder
编号(Code) 尺寸(Size)
LS29018 3X2X1cm



印章实心台座
Card Holder
编号(Code) 尺寸(Size)
LS29019 φ3X5cm



球形实心台座
Card Holder
编号(Code) 尺寸(Size)
LS29020 φ2.8XH2.5cm



2/3圆形实心台座
Card Holder
编号(Code) 尺寸(Size)
LS29021 4X4X3.5cm



小长方形实心台座
Card Holder
编号(Code) 尺寸(Size)
LS29029 4X1X1cm
LS29014 4X2X2cm



LS29111



LS29112



LS29113



LS29115



扇形餐牌
Menu Stand

编号(Code)	尺寸(Size)
LS29111	5/6/8/10/11/12/13/14/16/18 #
LS29112	5/6/8/10/11/12/13/14/16/18 #
LS29113	5/6/8/10/11/12/13/14/16/18 #
LS29115	5/6/8/10/11/12/13/14/16/18 #

心形扇形餐牌座
Card Holder

编号(Code)	尺寸(Size)
LS29007-1	15cm
LS29007-2	20cm
LS29007-3	25cm
LS29009-1	16cm
LS29009-2	24cm

桌面系列

桌面系列



X形餐牌座
Card Holder
编号(Code) 尺寸(Size)
LS29008-1 15cm
LS29008-2 20cm
LS29008-3 25cm
LS29010-1 16cm
LS29010-2 24cm



X形台号牌
Card Holder
编号(Code) 尺寸(Size)
LS29116 H16.8cm 11X6.2cm



I形台号牌
Card Holder
编号(Code) 尺寸(Size)
LS29119 9cmXH9.3cm



大英文留座牌
Reserved Table Sign
编号(Code) 尺寸(Size)
LS29005 12cm



大号“数字”座牌
Table Number
编号(Code) 尺寸(Size)
LS29121 15cm



空心菜单座
Table Number
编号(Code) 尺寸(Size)
LS26003 118X61X30mm



双边台号牌
Table Number
编号(Code) 尺寸(Size)
LS29011 H12cm 11x6.2cm
LS29011-2 H16.8cm 11x6.2cm
LS29011-3 H13.5cm 11x6.2cm



高托莲花实心台座
Table Number Stand
编号(Code) 尺寸(Size)
LS29117 H450mm



高托花鼓实心台座
Table Number Stand
编号(Code) 尺寸(Size)
LS29118 H380mm



天鹅水果叉套装
Fruit Set
编号(Code) 工艺(polish)
LS26001 银色(Silvery)
LS26002 金色(Golden)



电镀, 牙签筒
Toothpicks Holder
编号(Code) 工艺(polish)
LS26205 银色(Silvery)



电镀, 牙签筒
Toothpicks Holder
编号(Code) 工艺(polish)
LS26206 金(Golden)



不锈钢台号牌
Table Number Stand
编号(Code) 尺寸(Size)
LS29120-1 H280mm
LS29120-2 H380mm
LS29120-3 H480mm



半圆台号牌
Menu Stand With Gold
编号(Code) 尺寸(Size)
LS29122-6 6"
LS29122-12 12"



台号牌 (1-60)
Table Number
编号(Code) 尺寸(Size)
LS29001 5cm



天鹅水果叉套装
Fruit Set
编号(Code) 工艺(polish)
LS26003 银色(Silvery)
LS26004 金色(Golden)



电镀滴白胶, 牙签筒
Toothpicks Holder
编号(Code) 工艺(polish)
LS26207 银色(Silvery)



电镀滴白胶, 牙签筒
Toothpicks Holder
编号(Code) 工艺(polish)
LS26008 金(Golden)



小号禁烟牌
No Smoking Warning Sign
编号(Code)
LS29002



大号禁烟牌
No Smoking Warning Sign
编号(Code)
LS29003



中英文留座牌
Reserved Table Sign
编号(Code)
LS29004



指示牌 (清扫中)
Indicator
编号(Code) 尺寸(Size)
LS29123 200X260X365mm



指示牌 (泊车)
Indicator
编号(Code) 尺寸(Size)
LS29123 200X260X365mm



指示牌 (小心地滑)
Indicator
编号(Code) 尺寸(Size)
LS29123 200X260X365mm

PITO®

调味罐

生活不过是柴米油盐酱醋，
却能带来愉悦的心情，
因为品味美好的东西，
活出一种精致的仪式感



胡椒罐/磨油瓶



两味罐
Sauce Set 2pcs
编号(Code) 尺寸(Size)
LS26009 19cmx10.5cmx13.5cm



三味罐
Sauce Set 3pcs
编号(Code) 尺寸(Size)
LS26010 27.5cmx10.5cmx13.5cm



油醋瓶
Oil And Vinegar Set, 2pcs
编号(Code) 尺寸(Size)
LS26011 17.6cmx22cm



油醋瓶套装
Oil And Vinegar Set, 4pcs
编号(Code) 尺寸(Size)
LS26012 140mmx180mmx224mm



油醋瓶套装
Oil And Vinegar Set, 4pcs
编号(Code) 尺寸(Size)
LS26013 72x76x26mm



油醋瓶套装
Oil And Vinegar Set, 6pcs
编号(Code) 尺寸(Size)
LS26015 234mmx122mm
LS26018 234mmx122mm



胡椒粉筒
Salt And Pepper Set
编号(Code) 尺寸(Size)
LS26017 6x8cmH
LS26018 6x8cmH



拱桥圆形粉瓶两件套
Salt And Pepper Set
编号(Code) 尺寸(Size)
LS26019 7cmx8cm



胡椒粉套装
Salt And Pepper Set
编号(Code) 尺寸(Size)
LS26020 46mmx95mm



LS26021
LS26022
胡椒粉筒套装
Salt And Pepper Set
编号(Code) 尺寸(Size)
LS26021 High 13 cm wide, 7 cm
LS26022 High 8 cm wide, 7 cm



油醋瓶
Olive Oil Orvingsprayer
编号(Code) 尺寸(Size)
LS26023 dia.4x18hcm
LS26025 65mmx160mm



不锈钢油醋瓶
Olive Oil Orvingsprayer
编号(Code) 尺寸(Size)
LS26024 dia.4x18hcm



不锈钢研磨器
Stainless Steel Papper Mill
编号(Code) 尺寸(Size)
LS26027 45mmx195mm



不锈钢研磨器
Stainless Steel Papper Mill
编号(Code) 尺寸(Size)
LS26028 15cmx2.5cm

胡椒罐/磨油瓶

PITO®



汁碟
Sauce Dish
编号(Code) 尺寸(Size)
LS80012 8cmx15cm
LS80013 8cmx15.5cm



迷你食物薯条桶
Mini Food French Fries Bucket
编号(Code) 尺寸(Size)
LS80014 68mmx90mmx90mm



迷你食物薯条桶
Mini Food French Fries Bucket
编号(Code) 尺寸(Size)
LS80015 80mmx110mmx110mm



法式煎蛋筒蘸水杯
French Fry Cone Dipping Cups
编号(Code) 尺寸(Size)
LS80016 230mmx106mm



法式煎蛋筒蘸水杯
French Fry Cone Dipping Cups
编号(Code) 尺寸(Size)
LS80017 148mmx100mm



创意迷你食物篮
Creative mini food baskets
编号(Code) 尺寸(Size)
LS80018 330mmx300mmx270mm



烧烤架
Barbecue shelf
编号(Code) 尺寸(Size)
LS80019 145mmx125mmx284mm



餐具桶
Cutlery Holder
编号(Code) 尺寸(Size)
LS26028 11cmx13.2cm
LS26029 11cmx13.2cm
LS26030 10cmx12.4cm



餐具桶
Cutlery Holder Set
编号(Code) 尺寸(Size)
LS26032 20cmX24cm



餐具架套装
Cutlery Holder Set
编号(Code) 尺寸(Size)
LS26031 10.2cmx21.5cmx19.5cm



餐具架
Cutlery Holder Set
编号(Code) 尺寸(Size)
LS26033 L23XW8.5XH3cm

PITO® 精致茶壶咖啡壶

长颈茶壶咖啡壶，
表面光洁度高，与盖子匹配，并提供多种容量的选择

LONGWELL teapot coffee pot, with high surface finish and, the body matches the lid, and offers a variety of capacity options



咖啡壶/茶壶/保温壶/水壶

烧烤架/煎油架

保温壶
Vacuum Jug

PITO®



型号(Item No)	容量(Capacity)	装箱数量
LS98203	0.35L	6只/箱
LS98206	0.8L	6只/箱
LS98210	1.0L	6只/箱
LS98215	1.5L	6只/箱
LS98220	2.0L	6只/箱

S/S保温壶



- Red
- Blue
- Mirror
- Silver



- Red
- Blue
- Mirror
- Silver

型号(Item No)	容量(Capacity)	装箱数量
LS80210C	1.0L	6只/箱
LS80215C	1.5L	6只/箱

PITO®



型号(Item No)	规格(Capacity)	装箱数
LS13010A	1.0L	12只/箱
LS13015A	1.5L	12只/箱
LS13020A	2.0L	12只/箱

型号(Item No)	容量(Capacity)	装箱数
LS13710F	1.0L	12只/箱
LS13715F	1.5L	12只/箱
LS13720F	2.0L	12只/箱



型号(Item No)	容量(Capacity)	装箱数量
LS81715	0.35L	6只/A箱



型号(Item No)	容量(Capacity)	装箱数
LS13505C	0.4L	/
LS13506C	0.75L	/
LS13510C	1.0L	/
LS13515C	1.5L	/

咖啡壶/茶壶/保温壶系列

咖啡壶/茶壶/保温壶系列

PITO®



LS05001

LS51430

S/S气压壶

LS12230T

LS12130R

型号(Item No)	容量(Capacity)	装箱数
LS51430	3.0L	2只/箱
型号(Item No)	名称(name)	装箱数
LS05001	气压咖啡壶	/

型号(Item No)	容量(Capacity)	装箱数
LS12230T	3.0L	6只/箱
型号(Item No)	容量(Capacity)	装箱数
LS12130R	3.0L	6只/箱



LS52108

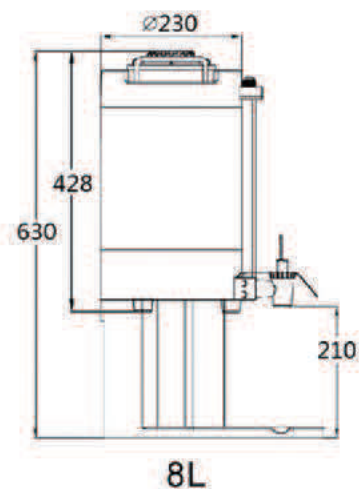

型号(Item No)	容量(Capacity)	装箱数
LS52108	8.0L	1只/箱

PITO®



咖啡壶
Coffee Pot
编号(Code) 尺寸(Size)
LS15001-1 360ml
LS15001-2 800ml
LS15001-3 1000ml



咖啡壶
Coffee Pot
编号(Code) 尺寸(Size)
LS15002-1 21X9.5X16.5cm 660ml
LS15002-2 83X205X100mm 450ML
LS15002G 93X205X100mm 450ML



咖啡壶
Coffee Pot
编号(Code) 尺寸(Size)
LS15003P 106X210X135mm 420ml
LS15003-1 280X120X160mm 600ml
LS15003-2 260X105X145mm 420ml



咖啡/茶壶
Coffee/tea Pot
编号(Code) 尺寸(Size)
LS15004 6.5cmx15.3cmx100ml



咖啡/茶壶
Coffee/tea Pot
编号(Code) 尺寸(Size)
LS15005 14.5cmx16.5cmx150ml



咖啡/茶壶
Coffee/tea Pot
编号(Code) 尺寸(Size)
LS15006 12cmx14cmx135ml



咖啡/茶壶加热器
Heater For Tea
编号(Code) 尺寸(Size)
LS15101 200mm 82mm



酒精燃架
Heater For Tea
编号(Code) 尺寸(Size)
LS15102 128mm 48mm



奶壶/拉花杯
Milk Jugs
编号(Code) 尺寸(Size)
LS22235 0.35L
LS22260 0.60L
LS22210 1.0L
LS22215 1.5L



不锈钢量杯
Milk Jugs With Measuring
编号(Code) 尺寸(Size) 编号(Code) 尺寸(Size)
LS22005 0.5L LS22015 1.5L
LS22007 0.7L LS22020 2.0L
LS22010 1.0L



抛光咖啡杯套装
Coffee Cup
编号(Code) 尺寸(Size)
LS15201-1 110X62X114 182g
LS15201-2 116X69X122 250g
LS15201-3 131X85X138 280g



抛光咖啡杯套装
Coffee Cup
编号(Code) 尺寸(Size)
LS15202 500ml

咖啡壶/茶壶/加热器系列

咖啡壶/茶壶/加热器系列

PITO®



咖啡杯

Coffee Cup

编号(Code) 尺寸(Size)
LS15204-1 47.5x37x20cm
LS15204-2 60x46.5x25.5cm
LS15204-3 36x34.6x35.6cm



凹点双层咖啡杯

Coffee Cup

编号(Code) 尺寸(Size)
LS15203 7.5XH6.8cm
LS15203-1 8.5XH7.5cm



银质杯托

Coffee Cup

编号(Code) 尺寸(Size)
LS15206 银色



不锈钢调料盒

Stainless Steel Milk And Sugar Set

编号(Code) 尺寸(Size)
LS15205 57mmx80mm 70mmx82mm



手冲咖啡套装

Coffee Set

编号(Code) 尺寸(Size)
LS15301 160X215X270mm



不锈钢滤网

Stainless steel strainer

编号(Code) 尺寸(Size)
LS15304 132X1113X86mm



压花玻璃滤杯

Coffee Set

编号(Code) 尺寸(Size)
LS14313 108X108X86mm



铜手冲架

Coffee Set

编号(Code) 尺寸(Size)
LS15303 108X108X86mm



不锈钢筛粉器

Stainless steel sieve powder

编号(Code) 尺寸(Size)
LS15307 73X73X115mm



手冲咖啡壶

Coffee Set

编号(Code) 尺寸(Size)
LS15305-1 105X135X105mm(850ml)
LS15305-2 120X145X125mm(650ml)



红檀木柄压粉锤

Spoon holder

编号(Code) 尺寸(Size)
LS15306 58X58X95mm

PITO®

酒吧用品系列

本着“客户至上，求实创新”的经营理念，与时俱进，不断完善，为广大客户提供“高品质，高标准，高档次”的酒吧用品及“优质，高效”的服务。



酒吧用品系列

咖啡杯/茶壶/保温壶系列



欧式调酒器
Hotel table number
编号(Code) 尺寸(Size)
LS24325-1 350ml
LS24325-2 500ml
LS24325-3 750ml



带刻度鸡尾酒雪克摇杯
Hotel table number
编号(Code) 尺寸(Size)
LS24326 21.5mmX5.7mm



调酒安士杯
Hotel table number
编号(Code) 尺寸(Size)
LS24327 1-100ML



开瓶器
cork screw
编号(Code) 尺寸(Size)
LS24222 185mmx70mm



开瓶器
bottle opener
编号(Code) 尺寸(Size)
LS24316 18cmX4cm



冰桶系列



镀铬酒樽头
Metal Free Pourer
编号(Code)
LS24328



量度酒樽头
Measured Pourer
编号(Code)
LS24329



滤冰器
s/a cocktail ice filter strainer
编号(Code)
LS24330



茶餐厅冰桶
Ice Bucket
编号(Code) 尺寸
LS25320 14.5cmx13.5cm



锤点冰桶锤铜冰粒桶
Ice Bucket
编号(Code) 尺寸(Size)
LS25321 11X12cm



碎冰锤
Ice Hammer
编号(Code)
LS24331



红酒塞
Vacuum Stoppers
编号(Code) 尺寸(Size)
LS24314 35mmx19mm



红酒塞
Vacuum Stoppers
编号(Code) 尺寸(Size)
LS24315 35mmx19mm



开瓶器
Wine Opener
编号(Code)
LS24317



开瓶器
Wine Opener
编号(Code) 尺寸(Size)
LS24318 15cm



开瓶器
cork screw
编号(Code) 尺寸(Size)
LS24221 180mmx80mm



高档冰料桶 (抛光/砂光)
Double wall ice bucket
编号(Code) 尺寸(Size)
LS25311 14X14X14cm



高档冰桶
Double wall ice bucket
编号(Code) 尺寸(Size) 高度 大小
LS25310-1 110 200 1L
LS25310-2 125 220 2L

PITO®



带盖提手双层冰桶
Double wall ice bucket
编号(Code) 尺寸(Size)
LS25322 L14cmXH14cm



手抓圆形冰桶
Double wall ice bucket
编号(Code) 尺寸(Size)
LS25309-1 17cmX13cm 1L
LS25309-2 22.6cmX14cm 2L



24QT锤点双层冰桶
Double wall ice bucket
编号(Code) 大小(Size) 尺寸(Desc)
LS25305 24QT 锤点双层餐桶 W42.5XH27.5cm

PITO®



电镀玫瑰金滨治盆
Stainless steel wine rack
编号(Code) 大小(Size) 尺寸(Desc)
LS25325 10L D398XH245mm



豪华香槟桶
Ice Bucket
编号(Code) 工艺 尺寸(Size)
LS25308-1 银耳 190x220mm 4.5L
LS25308-2 金耳 190x220mm 4.5L



(欧式) 不锈钢香槟桶
Ice Bucket
编号(Code) 工艺 尺寸(Size)
LS25323 银耳 190XH220mm
LS25323G 金耳 190XH220mm



全钢一品红酒架
Wine Rack
编号(Code) 尺寸(Size)
LS24105 150mmx90mmx245mm



全钢圆环红酒架
Wine Rack
编号(Code) 尺寸(Size)
LS24119 245mmx250mmx90mm



(欧式) 不锈钢香槟桶架
stand for wine/champagne cooler
编号(Code) 尺寸(Size)
LS25324 Φ200X750mm
LS25324-1 Φ200X610mm
LS25307 Φ190X750mm
LS25307-1 Φ190X610mm



6QT锤点双层冰桶
Double wall ice bucket
编号(Code) 大小(Size) 尺寸(Desc)
LS25306 6QT 锤点双层餐桶 W26XH20cm



月牙红酒架
Wine Rack
编号(Code) 尺寸(Size)
LS24110 235mmx100mmx200mm



L型红酒架
Wine Rack
编号(Code) 尺寸(Size)
LS24121 235mmx100mmx200mm



全钢炮型酒架
Wine Rack
编号(Code) 尺寸(Size)
LS24120 225mmx100mmx100mm

咖啡壶/茶壶/保温壶系列

酒吧用品系列

自助餐炉

Chafing Dishes

优质不锈钢

18/10 stainless steel .



适用于固体燃料或电加热。 提供水盘，食物盘和燃料架 Suitable for both solid-fuel or electric heating. Supplied with water pan, food pan and fuel holder



长方形节能豪华自动餐炉(电热锅)

Electric Frying Pan

编号(Code): LS31001

电压:220 - 240 v 功率:2200 w

尺寸:40.64X28X5.5cm



正方形节能豪华自动餐炉(电热锅)

Multifunctional pot

编号(Code):LS31002

电压:220 - 240 v 功率:2200w

尺寸:33X33x6.6cm



蛋形多功能煮食锅

Electric Frying Pan

编号(Code):LS31003

电压:220 - 240 v 功率:2200 w

尺寸:38X26X12.5cm



圆形节能火锅料理锅

Electric Frying Pan

编号(Code):LS31004

电压:220 - 240 v 功率:13500 w

尺寸:30X30X4.5cm



圆形节能电煎锅

Electric Frying Pan

编号(Code):LS31005

电压:220 - 240 v 功率:13500 w

尺寸:30X30X10cm



圆形奥斯自助餐炉
Stainless Steel Round Chafing Dishes
匹配:6.8 l / φ 36cm圆形食物板(不含架子上)

W510 H195
编号(Code):LS36120
L520 W510 H195mm



1/2方形奥斯自助餐炉
Chafing Dishes With Holder

配:1/1x65mm5.5L餐盘
(W35120+35327)
L480 W446 H180mm
编号(Code):LS35320-1



圆形奥斯自助餐炉
Stainless Steel Round Chafing Dishes
匹配:6.8 l / φ 36cm圆食品板块

(W36120+3627) W510 H310mm
编号(Code):LS36320



方形全翻盖自助餐炉
Stainless Steel Chafing Dish With Glass Window Lid

编号(Code):LS01-2011
匹配:1/1x65mm8.5L食物板(不含架子上)
编号(Code):LS01-2012
匹配:two1/1x65mm4.5L食物板(双食品盆)



方形奥斯自助餐炉
Chafing Dishes

匹配:1/1x65mm8.5L食物板(不含架子上)
编号(Code):LS37320
L665 W465 H205
L665 W465 H205mm



方形全翻盖自助汤炉
Stainless Steel Chafing Dish With Glass Window Lid

编号(Code):LS01-2018
配:2个4.0升汤桶
L710 W510 H450mm



方形奥斯自助餐炉
Chafing Dishes With Holder

配:1/1x65mm8.5L餐盘
(W37120+37327)
编号(Code):LS37320-1
W465 H205mm L665
L665 W465 H320mm



圆形全翻盖自助汤炉
Stainless Steel Chafing Dish With Glass Window Lid

编号(Code):LS02-2018
匹配:5.0 l汤桶
L530 W525 H490mm



1/2方形奥斯自助餐炉
Chafing Dishes

匹配:2/3x65mm5.5L食物板(不含架子上)
W465 H205
编号(Code):LS35120

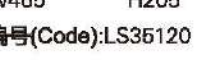

圆形全翻盖自助餐炉
Stainless Steel Chafing Dish With Glass Window Lid

编号(Code):LS02-2011
匹配:6.8升/ 36cm食物盆
L530 W525 H490mm





方形双盆全翻盖餐炉

stainless steel chafing dish
配: 2个1/2x65mm 4.5升食物盆
编号(Code):LS32229V



揭盖式方形自助餐炉

Stainless Steel Chafing Dish
编号(Code):LS28187S
配: 1/1X65mm 8.5L 食物盆
编号(Code):LS28287S
配: 两个 1/2X65mm 4.5L食物盆



圆形全翻盖餐炉

stainless steel chafing dish
配: 6.8L/φ36cm食物盆
编号(Code):LS32621V



不锈钢单头果汁鼎

Juice Dispensers
编号(Code):LS23688P-1 8.0L

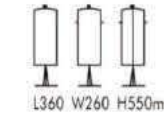

方形全翻盖自助汤炉

Stainless Steel Chafing Dish for Soup
配: 两个 4L 汤桶
编号(Code):LS32129BV



不锈钢双头果汁鼎

Juice Dispensers
编号(Code):LS23688PX2-1 8.0Lx2

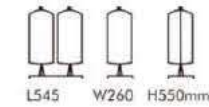

Tomlinson Faucet



圆形全翻盖自助汤炉

Stainless Steel Chafing Dish for Soup
配: 5L 汤桶
编号(Code):LS32621BV



5L双头果汁鼎

Juice Dispensers
编号(Code):LS23588X2 5.0Lx2

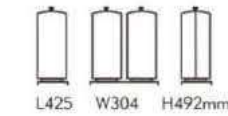

方形自助餐炉 (经济型)

stainless steel chafing dish
编号(Code):LS25188V
配: 1/1x6.5cm 8.5L 食物盆



5升单头果汁鼎

Mini Transparent Cooling Juice Dispenser
编号(Code):LS3588 5L



中间空心柱可放置冰块, 冰爽效果更好



钢座果汁鼎 Juice dispensers

编号(Code):LS14-1000 5L

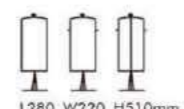

Tomlinson Faucet



钢座三头麦片分配器

Breakfast Dry Food Cereal Dispenser

编号(Code):LS13-1300 4.0LX3

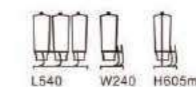

方形维娜果汁鼎

Plastic Cold Dispenser

编号(Code):LS17-2000 11.4L

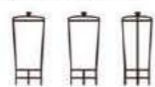

L260 W295 H580mm



不锈钢咖啡/果汁/饮料分配器

Stainless Steel Coffee / Juice / Beverage Dispenser

编号(Code):LS23673-1 10.5L

配: 火酒杯加热, 也适用于电热杯, 加热板加热。
It is also used for heating electric cups and heating plates.

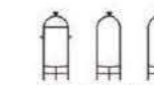

L310 W335 H545mm



不锈钢单头麦片分配器

Breakfast Dry Food Cereal Dispenser

编号(Code):LS23677 容量:7.0L

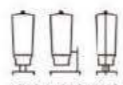

L240 W330 H540mm



不锈钢咖啡/果汁/饮料分配器

Stainless Steel Coffee / Juice / Beverage Dispenser

编号(Code):LS23674 10.5L

配: 火酒杯加热, 也适用于电热杯, 加热板加热。

It is also used for heating electric cups and heating plates.



钢座单头麦片分配器

Breakfast Dry Food Cereal Dispenser

编号(Code):LS13-1100 4.0L



L185 W240 H605mm



伊亚咖啡鼎

Milk dispenser with fuel holder for warming

编号(Code):LS19-30007 5L

编号(Code):LS19-40007 12L

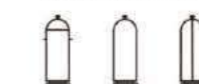

L320 W262 H510mm



双头麦片分配器

Breakfast Dry Food Cereal Dispenser

编号(Code):LS13-1200 4.0升X2



L360



W240



H605mm



伊亚牛奶鼎

Milk dispenser with fuel holder for warming

编号(Code):LS16-30007 5L

编号(Code):LS16-40007 12L



L320 W262 H468mm



Pc盖电子暖汤煲 Stainless Steel Cover Electric Soup Warmer

编号(Code):LS97328-7

capacity:10.0L voltage:220C AC,power:400W



电热杯

Buffet Accessories Chafing Dish Electric Heating Board

编号(Code):LS35007PTC

电压:220V 50/60HZ

功率:350W

* 加热快, 控制精准

* 防干烧, 不伤锅具

* 防烫伤, 适用于自助餐炉、咖啡机加热



不锈钢盖电子暖汤煲 Pc Cover Electric Soup Warmer

编号(Code):LS87328

Capacity:10.0L voltage:220C AC,power:400W



CIC2000-7(嵌入专用)

嵌入专用炉

220v Buffet Accessories Chafing Dish Electric Heating Board

编号(Code):LS2000-7

尺寸:302X372X80mm

电压:220V 50HZ

功率调节范围:500W-2000W

温度调节范围:60C-240C



全不锈钢电子暖汤煲 Electric Soup Warmer

编号(Code):LS83388-7 10L

电压:220VAC 功率:380W 容量:10L



电热板

buffet accessories chafing dish electric heating board

编号(Code):LS-E03

电压:220VAC 50HZ 功率:310W

尺寸:250x200x20mm

材质:铝合金

适用于:长方形自助餐炉



杯架

Cup Rack With One Top Serving Cup Plate.Spoons

编号(Code):LS09-1000

L400 W400 H650mm

温馨提示:

咖啡杯规格范围、直径80~85mm

咖啡碟规格范围、直径小于145mm

咖啡匙规格范围、长度100~120mm

Unique design, patented products, easy to access;

Stable structure, comfortable and applicable;

Flexible rotation, quiet and noiseless



带温控电热板

Buffet Accessories Chafing Dish Electric Heating Board

编号(Code):LS-3152A

电压:220VAC 50HZ 功率:250W

尺寸:200mm

材质:铝合金

适用于:圆形自助餐炉

不锈钢美式份数盘 stainless steel gastronorm containers



选择我们的常规容器
Choose between our regular containers
可用于自助餐，储存食品原料和配料在冰箱等。
It can be used for serving food in buffet,
storing food raw materials and ingredients
in refrigerator, etc.



1/1份数盘 不锈钢



编号(Code)	规格(Depth Mm)	厚度 (Thickness)
LS42011Q	1/1x2.5' Gastronorm Pans 530x325x65	0.8mm
LS42012Q	1/1x4' Gastronorm Pans 530x325x100	0.8mm
LS42013Q	1/1x6' Gastronorm Pans 530x325x150	0.8mm
LS42014Q	1/1x8' Gastronorm Pans 530x325x200	0.8mm

1/2份数盘 不锈钢



编号(Code)	规格(Depth Mm)	厚度 (Thickness)
LS42021Q	1/2x2.5' Gastronorm Pans 325x265x65	0.8mm
LS42022Q	1/2x4' Gastronorm Pans 325x265x100	0.8mm
LS42023Q	1/2x6' Gastronorm Pans 325x265x150	0.8mm
LS42024Q	1/2x8' Gastronorm Pans 325x265x200	0.8mm

1/3份数盘 不锈钢



编号(Code)	规格(Depth Mm)	厚度 (Thickness)
LS42031Q	1/3x2.5' Gastronorm Pans 325x176x65	0.8mm
LS42032Q	1/3x4' Gastronorm Pans 325x176x100	0.8mm
LS42033Q	1/3x6' Gastronorm Pans 325x176x150	0.8mm
LS42034Q	1/3x8' Gastronorm Pans 325x176x200	0.8mm

1/4份数盘 不锈钢



编号(Code)	规格(Depth Mm)	厚度 (Thickness)
LS42041Q	1/4x2.5' Gastronorm Pans 265x162x65	0.8mm
LS42042Q	1/4x4' Gastronorm Pans 265x162x100	0.8mm
LS42043Q	1/4x8' Gastronorm Pans 265x162x150	0.8mm

1/6份数盘 不锈钢



编号(Code)	规格(Depth Mm)	厚度 (Thickness)
LS42061Q	1/6x2.5' Gastronorm Pans 162x176x65	0.8mm
LS42062Q	1/6x2.5' Gastronorm Pans 182x176x100	0.8mm
LS42063Q	1/6x4' Gastronorm Pans 162x176x150	0.8mm

1/9份数盘 不锈钢



编号(Code)	规格(Depth Mm)	厚度 (Thickness)
LS42091Q	1/9x6' Gastronorm Pans 176x108x65	0.8mm
LS42092Q	1/9x8' Gastronorm Pans 176x108x100	0.8mm

份数盘盖 不锈钢



编号(Code)	规格(Depth Mm)	厚度 (Thickness)
LS42101C	1/1' Gastronorm Pans 530x325	0.8mm
LS42102C	1/2' Gastronorm Pans 325x265	0.8mm
LS42103C	1/3' Gastronorm Pans 325x176	0.8mm
LS42104C	1/4' Gastronorm Pans 265x162	0.8mm
LS42105C	1/6' Gastronorm Pans 162x176	0.8mm
LS42106C	1/9' Gastronorm Pans 176x108	0.8mm

冲孔份数盘 不锈钢



编号(Code)	规格(Depth Mm)	厚度 (Thickness)
LS42111C	1/2x2.5' Gastronorm Pans 327x265x65	0.8mm
LS42112C	1/2x4' Gastronorm Pans 327x265x100	0.8mm
LS42113C	1/2x6' Gastronorm Pans 327x265x150	0.8mm
LS42114C	1/1x2.5' Gastronorm Pans 530x327x65	0.8mm
LS42115C	1/1x4' Gastronorm Pans 530x327x100	0.8mm
LS42116C	1/1x6' Gastronorm Pans 530x327x150	0.8mm