

PITO®

OEM/国外品牌 List Of OEM Client

SOLA

ONEIDA

AMEFA

Nestle

Zwilling

ETERNUM signature

Edelstahl

GS

PRAKASH

OEM/国内品牌 Oem/the Chinese Brand

山东航空
SHANDONG AIRLINES

深圳航空
SHENZHEN AIRLINES

好利来蛋糕
HOLLAND

哈尔滨远大购物集团
HAERBIN BROAD SHOPPING GROUP

星级酒店名录

Preformance Table For Hotel Projects

世界互联网大会

WIC(World Internet Conference)

福州融侨皇冠假日酒店

CROWN PLAZA

南京丽湖大酒店

Lake Home Nanjing

上海明捷万丽酒店

Renaissance Shanghai Putuo Hotel

万和亚隆国际酒店

Onehome Y.L. Int'l Hotel Shanghai

三亚福朋喜来登度假酒店

Four Points by Sheraton Hainan, Sanya

广州花园酒店

The Garden Hotel

贵阳喜来登酒店

Sheraton Hotel GuiYang

深圳福朋喜来登

Four Points by Sheraton Shenzhen Hote

中国大酒店

China Hotel A Marriott Hotel Guang Zhou

北京燕京海航大酒店

Yanjing Hotel Beijing

厦门京闽中心酒店

Jingmin Central Hotel Xiamen

宁波威斯汀

Westin Ningbo

宁波洲际

Ningbo Intercontinental

昆山兰博基尼酒店

Tonino Lamborghini Hotel Kunshan City Center

广州威斯汀

The Westin Pazhou

泉州安溪悦泉行馆

Elite Spring Villas

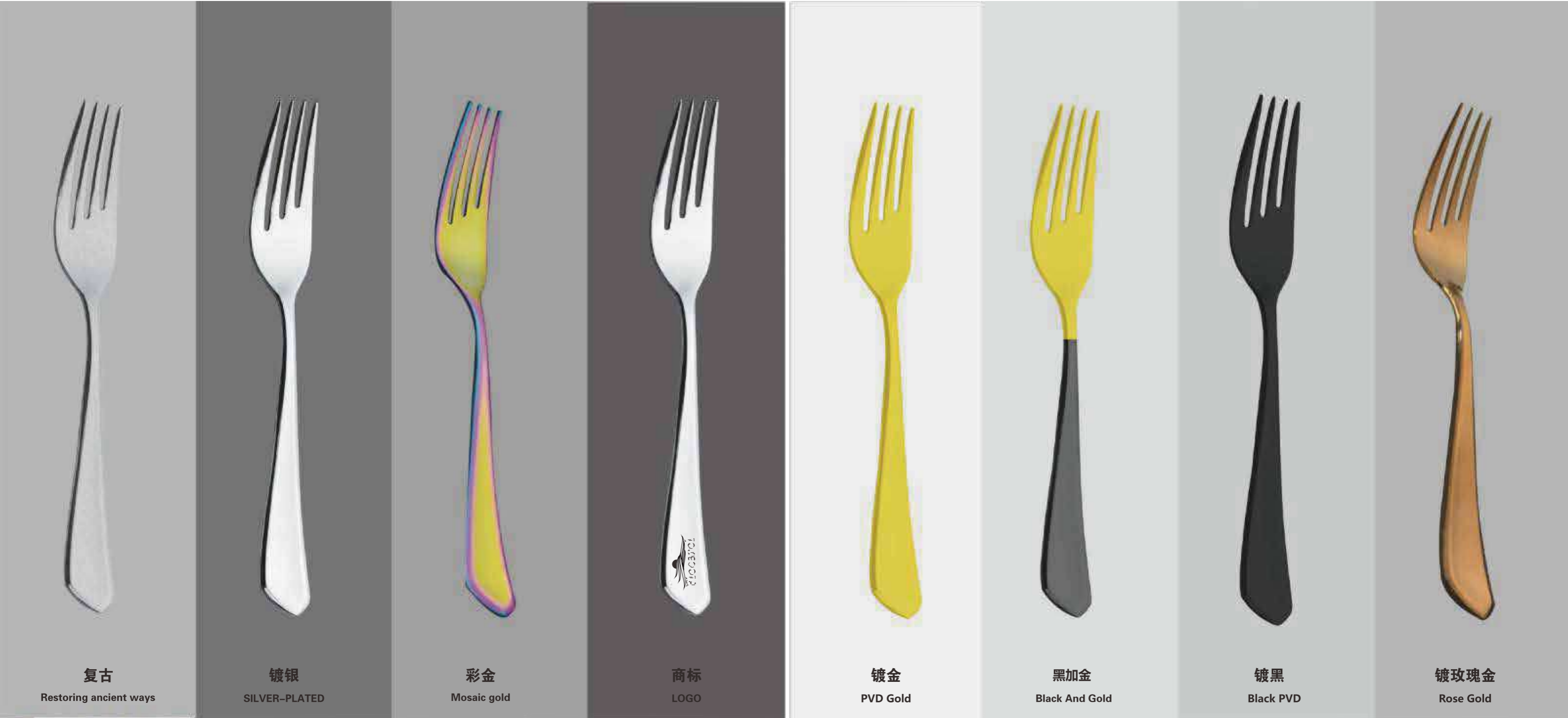

- 所有产品，接受公司名字，LOGO个性化定制服务，采用激光或压制工艺。
All items can be personalized (company name, logo, etc.) using laser engraving or stamping technology.
- 所有材料均符合食品接触检验标准。
All materials used are in accordance with laws governing food and beverages
- 产品符合机洗安全测试
All items are dishwasher safe

- 表面处理是PVD工艺，在航空航天技术里面应用广泛，表面坚硬耐磨，颜色热情，适合特色的酒店，餐厅和餐饮服务

The surface treatment is a P.V.D. process (Physical Vapour Deposition) This technology was developed for the aeronautic industry and is used to shield The characteristics of these treatments are hard wearing and hospitality grade -ideal for distinctive hotels, restaurants and catering services.

CN118

Stainless Steel
5.0mm

	Desc.	Size
正餐刀	Table Knife	233mm
正餐叉	Table Fork	201mm
正餐更	Table Spoon	198mm
甜品刀	Dessert Knife	203mm
甜品叉	Dessert Fork	172mm
甜品更	Dessert Spoon	174mm
牛排刀	Steak Knife	227mm
汤更	Soup Spoon	185mm
蛋糕叉	Cake Fork	144mm
水果叉	Fruit Fork	136mm
咖啡更	Coffee Spoon	138mm

	Desc.	Size
雪糕更	Ice Cream Spoon	163mm
摩卡更	Mocha Spoon	112mm
冰更	Ice Tea Spoon	190mm
黄油刀	Butter Knife	180mm
鱼刀	Fish Knife	195mm
鱼叉	Fish Fork	193mm
小提勺	Gravy Ladle	180mm
大提勺	Soup Ladle	320mm
服务更	Serving Spoon	220mm
服务叉	Serving Fork	220mm



	Desc.	Size		Desc.	Size
正餐刀	Table Knife	227mm	茶更	Tea Spoon	148mm
正餐叉	Table Fork	220mm	咖啡更	Coffee Spoon	123mm
正餐更	Table Spoon	211mm	黄油刀	Butter Knife	172mm
甜品刀	Dessert Knife	216mm	鱼刀	Fish Knife	210mm
甜品叉	Dessert Fork	191mm	鱼叉	Fish Fork	185mm
甜品更	Dessert Spoon	188mm	小提勺	Gravy Ladle	185mm
牛排刀	Steak Knife	240mm	大提勺	Soup Ladle	289mm
汤更	Soup Spoon	177mm	蛋糕铲	Cake Server	255mm
蛋糕叉	Cake Fork	147mm	沙拉叉	Salad Fork	213mm
水果叉	Fruit Fork	133mm	沙拉更	Salad Spoon	213mm

MC022-C

Stainless Steel
5.0mm

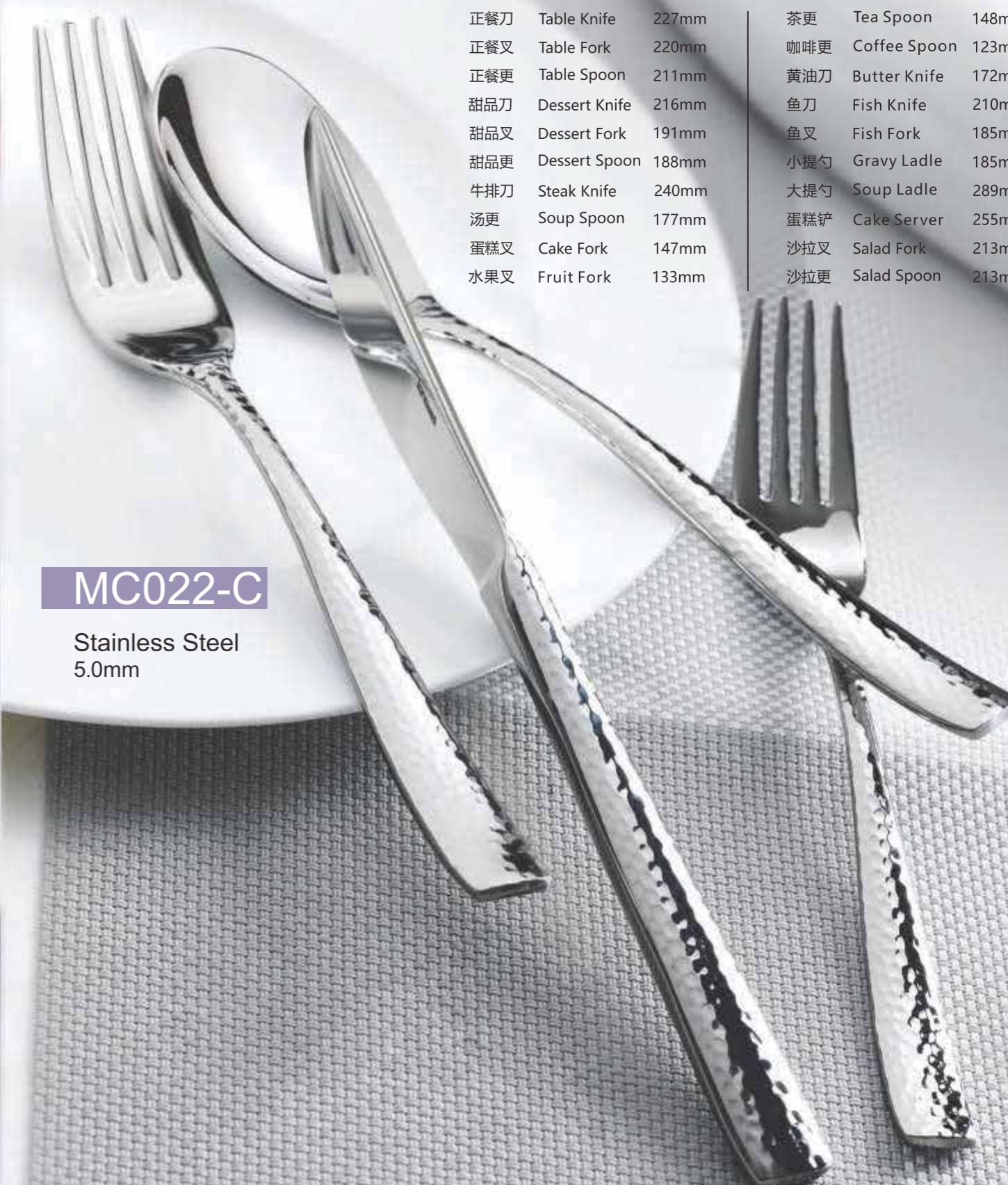

MC022

18/10 Stainless Steel
4.5mm

	Desc.	Size
正餐刀	Table Knife	225mm
正餐叉	Table Fork	219mm
正餐更	Table Spoon	210mm
甜品刀	Dessert Knife	217mm
甜品叉	Dessert Fork	188mm
甜品更	Dessert Spoon	186mm
牛排刀	Steak Knife	239mm
汤更	Soup Spoon	176mm
蛋糕叉	Cake Fork	147mm
茶更	Tea Spoon	150mm

	Desc.	Size
咖啡更	Coffee Spoon	127mm
黄油刀	Butter Knife	173mm
鱼刀	Fish Knife	209mm
鱼叉	Fish Fork	186mm
小提勺	Gravy Ladle	185mm
大提勺	Soup Ladle	280mm
蛋糕铲	Cake Server	254mm
沙拉叉	Salad Fork	212mm
沙拉更	Salad Spoon	214mm



LV006

18/10 Stainless Steel
6.0mm

	Desc.	Size
正餐刀	Table Knife	235mm
正餐叉	Table Fork	201mm
正餐更	Table Spoon	203mm
甜品刀	Dessert Knife	207mm
甜品叉	Dessert Fork	178mm
甜品更	Dessert Spoon	175mm
牛排刀	Steak Knife	242mm
汤更	Soup Spoon	188mm
茶更	Tea Spoon	145mm
蛋糕叉	Cake Fork	150mm
水果叉	Fruit Fork	140mm

	Desc.	Size
咖啡更	Coffee Spoon	110mm
黄油刀	Butter Knife	178mm
冰更	Ice Tea Spoon	213mm
鱼刀	Fish Knife	204mm
鱼叉	Fish Fork	202mm
蛋糕铲	Cake Server	247mm
小提勺	Gravy Ladle	228mm
大提勺	Soup Ladle	300mm
服务更	Serving Spoon	240mm
服务叉	Serving Fork	240mm
二号汤更	2# Soup Spoon	167mm



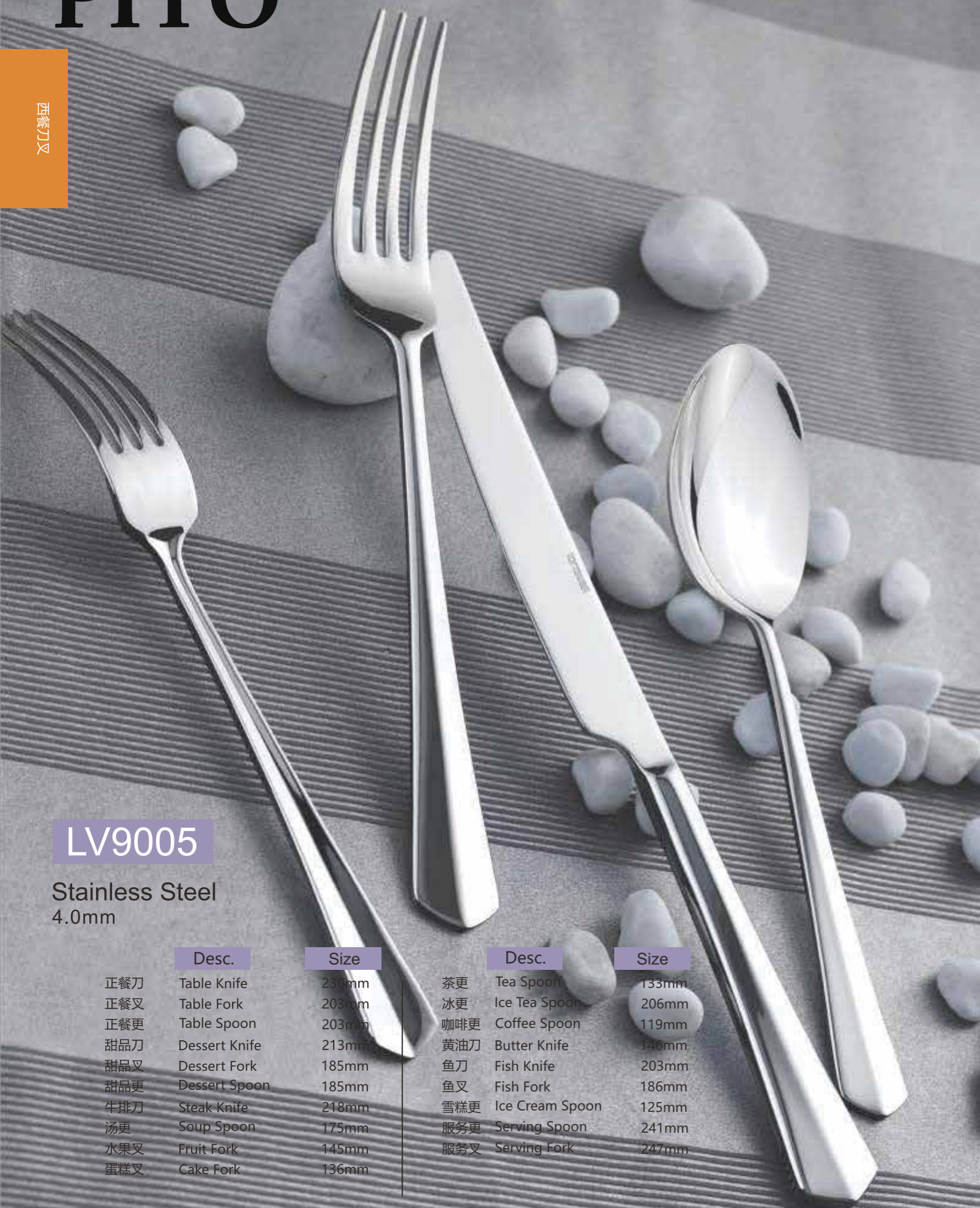

LV9005

Stainless Steel
4.0mm

	Desc.	Size
正餐刀	Table Knife	230mm
正餐叉	Table Fork	203mm
正餐更	Table Spoon	203mm
甜品刀	Dessert Knife	213mm
甜品叉	Dessert Fork	185mm
甜品更	Dessert Spoon	185mm
牛排刀	Steak Knife	218mm
汤更	Soup Spoon	175mm
水果叉	Fruit Fork	145mm
蛋糕叉	Cake Fork	136mm

	Desc.	Size
茶更	Tea Spoon	133mm
冰更	Ice Tea Spoon	206mm
咖啡更	Coffee Spoon	119mm
黄油刀	Butter Knife	146mm
鱼刀	Fish Knife	203mm
鱼叉	Fish Fork	186mm
雪糕更	Ice Cream Spoon	125mm
服务更	Serving Spoon	241mm
服务叉	Serving Fork	247mm

LV2022

18/10 Stainless Steel
4.0mm

	Desc.	Size
正餐刀	Table Knife	235mm
正餐叉	Table Fork	209mm
正餐更	Table Spoon	208mm
甜品刀	Dessert Knife	210mm
甜品叉	Dessert Fork	192mm
甜品更	Dessert Spoon	190mm
牛排刀	Steak Knife	235mm
汤更	Soup Spoon	190mm
水果叉	Fruit Fork	150mm

	Desc.	Size
茶更	Tea Spoon	150mm
咖啡更	Coffee Spoon	115mm
蛋糕叉	Cake Fork*	150mm
黄油刀*	Butter Knife*	165mm
冰更*	Ice Tea Spoon*	205mm
鱼刀*	Fish Knife*	190mm
鱼叉*	Fish Fork*	188mm
服务更*	Serving Spoon*	238mm
服务叉*	Serving Fork*	240mm

*表示没库存 (NO Stock)



LV2033

18/10 Stainless Steel
5.0mm

	Desc.	Size
正餐刀	Table Knife	235mm
正餐叉	Table Fork	204mm
正餐更	Table Spoon	203mm
甜品刀	Dessert Knife	212mm
甜品叉	Dessert Fork	182mm
甜品更	Dessert Spoon	185mm
牛排刀	Steak Knife	235mm
蛋糕叉	Cake Fork	144mm
水果叉	Fruit Fork	147mm

	Desc.	Size
汤更	Soup Spoon	178mm
咖啡更	Coffee Spoon	118mm
茶更	Tea Spoon	135mm
冰更	Ice Tea Spoon	201mm
鱼刀	Fish Knife	221mm
鱼叉	Fish Fork	204mm
黄油刀	Butter Knife	161mm
服务更	Serving Spoon	233mm
服务叉	Serving Fork	231mm

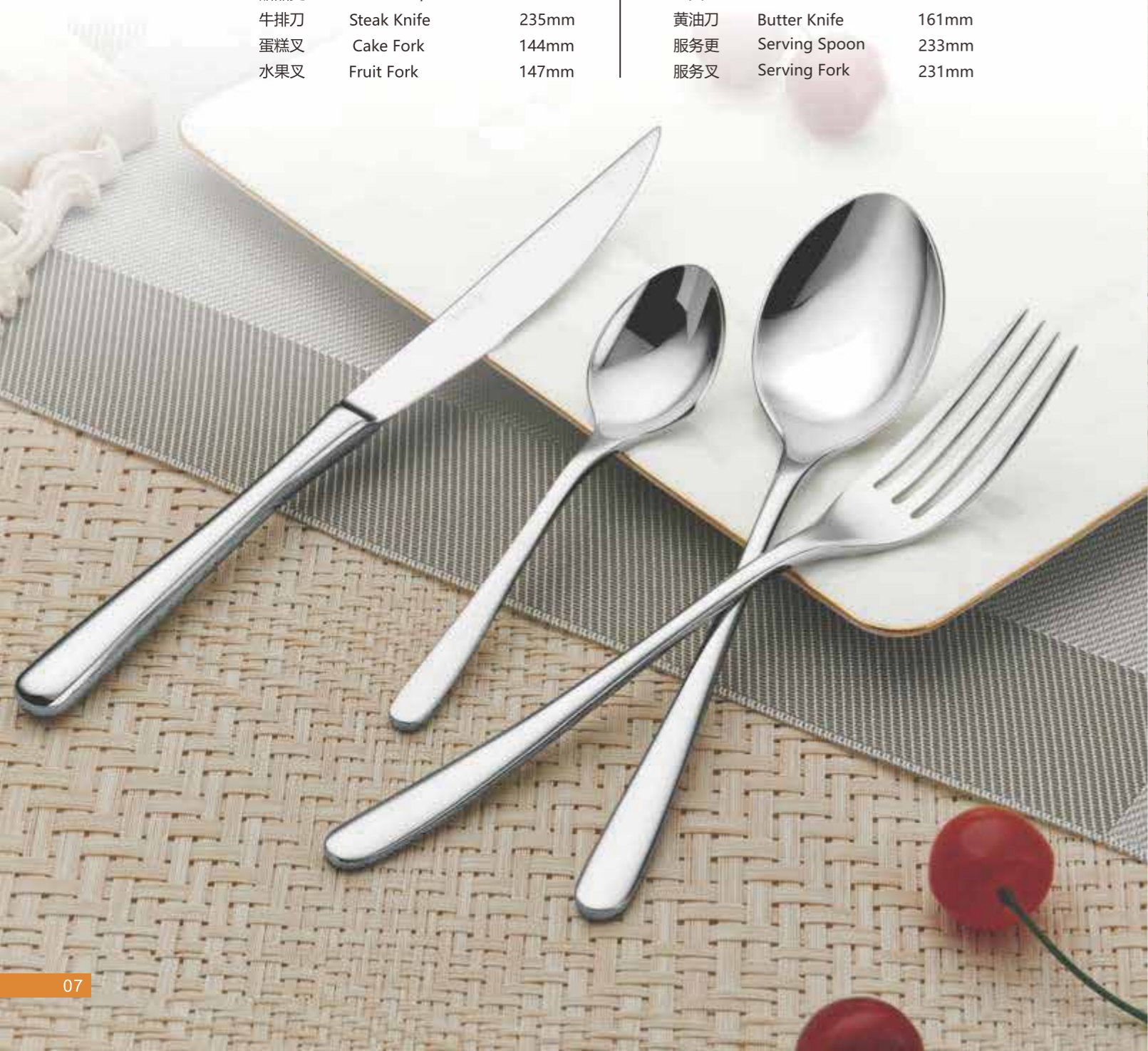

LV2026

18/10 Stainless Steel
4.0mm

	Desc.	Size
正餐刀	Table Knife	243mm
正餐叉	Table Fork	202mm
正餐更	Table Spoon	211mm
甜品刀	Dessert Knife	224mm
甜品叉	Dessert Fork	188mm
甜品更	Dessert Spoon	190mm
牛排刀	Steak Knife	243mm

	Desc.	Size
汤更	Soup Spoon	177mm
茶更	Tea Spoon	142mm
咖啡更	Coffee Spoon	114mm
蛋糕叉	Cake Fork	158mm
鱼刀	Fish Knife	208mm
鱼叉	Fish Fork	190mm
黄油刀	Butter Knife	174mm



LV2003

18/10 Stainless Steel
4.0mm

	Desc.	Size		Desc.	Size
正餐刀	Table Knife	244mm	茶更	Tea Spoon	142mm
正餐叉	Table Fork	211mm	咖啡更	Coffee Spoon	114mm
正餐更	Table Spoon	211mm	蛋糕叉	Cake Fork	158mm
甜品刀	Dessert Knife	224mm	黄油刀	Butter Knife	208mm
甜品叉	Dessert Fork	190mm	鱼刀	Fish Knife	204mm
甜品更	Dessert Spoon	190mm	鱼叉	Fish Fork	190mm
汤更	Soup Spoon	179mm			



LV2012

18/10 Stainless Steel
5.0mm

	Desc	Size		Desc	Size
正餐刀	Table Knife	245mm	咖啡更	Coffee Spoon	115mm
正餐叉	Table Fork	212mm	黄油刀	Butter Knife	183mm
正餐更	Table Spoon	214mm	蛋糕叉	Cake Fork	147mm
甜品刀	Dessert Knife	218mm	水果叉	Fruit Fork	147mm
甜品叉	Dessert Fork	193mm	服务更	Serving Spoon	260mm
甜品更	Dessert Spoon	193mm	漏餐更	PCB Spoon	257mm
牛排刀	Steak Knife	245mm	鱼刀	Fish Knife	181mm
汤更	Soup Spoon	184mm	鱼叉	Fish Fork	183mm
茶更	Tea Spoon	147mm			

高贵典雅的造型，轻柔美妙的触感，
让一切变得舒适，自然，昨日的无线
荣耀，在您今日的经典时尚。



CN618

18/10 Stainless Steel

4.0mm

	Desc.	Size
正餐刀	Table Knife	240mm
正餐叉	Table Fork	210mm
正餐更	Table Spoon	210mm
甜品刀	Dessert Knife	215mm
甜品叉	Dessert Fork	195mm
甜品更	Dessert Spoon	198mm
牛排刀	Steak Knife	238mm
汤更	Soup Spoon	195mm
水果叉	Fruit Fork	145mm
咖啡更	Coffee Spoon	138mm
摩卡更	Mocha Spoon	115mm

西餐刀叉



西餐刀叉

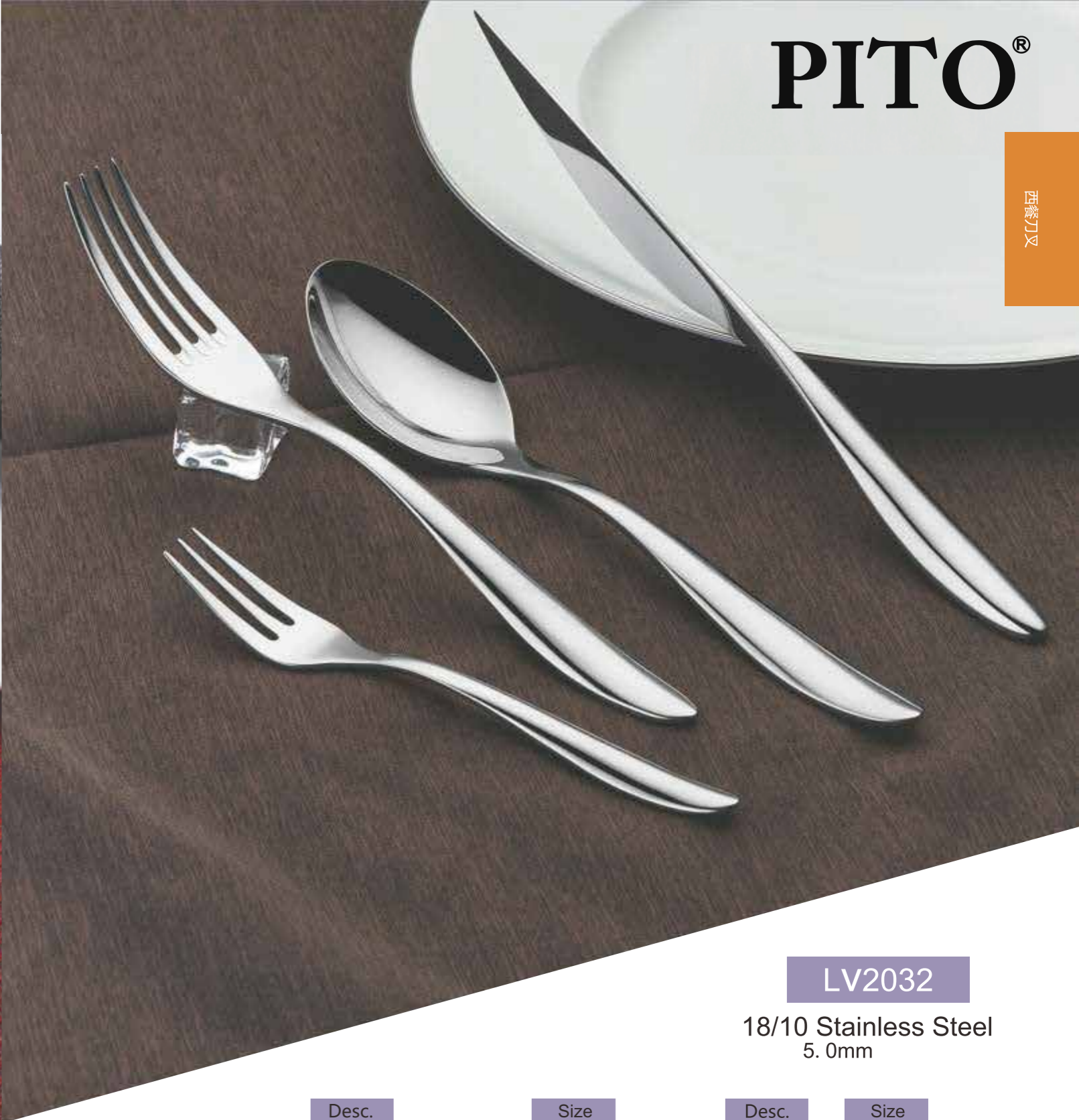

LV2032

18/10 Stainless Steel

5.0mm

	Desc.	Size
正餐刀 (立刀)	Table Knife(Standing Knife)	236mm
正餐叉	Table Fork	212mm
正餐更	Table Spoon	210mm
甜品刀 (立刀)	Dessert Knife(Standing Knife)	205mm
甜品叉	Dessert Fork	190mm
甜品更	Dessert Spoon	189mm
牛排刀 (立刀)	Steak Knife(Standing Knife)	235mm
汤更	Soup Spoon	193mm
蛋糕叉	Cake Fork	155mm
水果叉	Fruit Fork	142mm

	Desc.	Size
咖啡更	Coffee Spoon	120mm
茶更	Tea Spoon	138mm
鱼刀	Fish Knife	199mm
鱼叉	Fish Fork	182mm
黄油刀	Butter Knife	172mm
服务更	Serving Spoon	228mm
服务叉	Serving Fork	230mm



LV3101

18/10 Stainless Steel
3.5mm

Desc.	Size
正餐刀	Table Knife 248mm
正餐叉	Table Fork 207mm
正餐更	Table Spoon 207mm
甜品刀	Dessert Knife 218mm
甜品叉	Dessert Fork 186mm
甜品更	Dessert Spoon 185mm

Desc	Size
牛排刀	Steak Knife 232mm
汤更	Soup Spoon 182mm
蛋糕叉	Cake Fork 150mm
茶更	Tea Spoon 139mm
咖啡更	Coffee Spoon 105mm

LV2006

18/10 Stainless Steel
4.0mm

Desc.	Size
正餐刀	Table Knife 240mm
正餐叉	Table Fork 218mm
正餐更	Table Spoon 216mm
甜品刀	Dessert Knife 215mm
甜品叉	Dessert Fork 192mm
甜品更	Dessert Spoon 192mm
牛排刀	Steak Knife 242mm
茶更	Tea Spoon 135mm
咖啡更	Coffee Spoon 119mm
弯柄服务更	Serving spoon stand 245mm

Desc.	Size
汤更	Soup Spoon 188mm
水果叉	Fruit Fork 115mm
蛋糕叉	Cake Fork 140mm
冰更	Ice Tea Spoon 220mm
鱼刀	Fish Knife 226mm
鱼叉	Fish Fork 218mm
黄油刀	Butter Knife 158mm
服务更	Serving Spoon 255mm
服务叉	Serving Fork 253mm
沙拉叉	Salad Fork 255mm





LV3102

18/10 Stainless Steel
3.5mm

Desc.	Size	Desc.	Size		
正餐刀	Table Knife	248mm	牛排刀	Steak Knife	232mm
正餐叉	Table Fork	207mm	汤更	Soup Spoon	182mm
正餐更	Table Spoon	207mm	蛋糕叉	Cake Fork	150mm
甜品刀	Dessert Knife	218mm	茶更	Tea Spoon	139mm
甜品叉	Dessert Fork	186mm	咖啡更	Coffee Spoon	105mm
甜品更	Dessert Spoon	185mm			

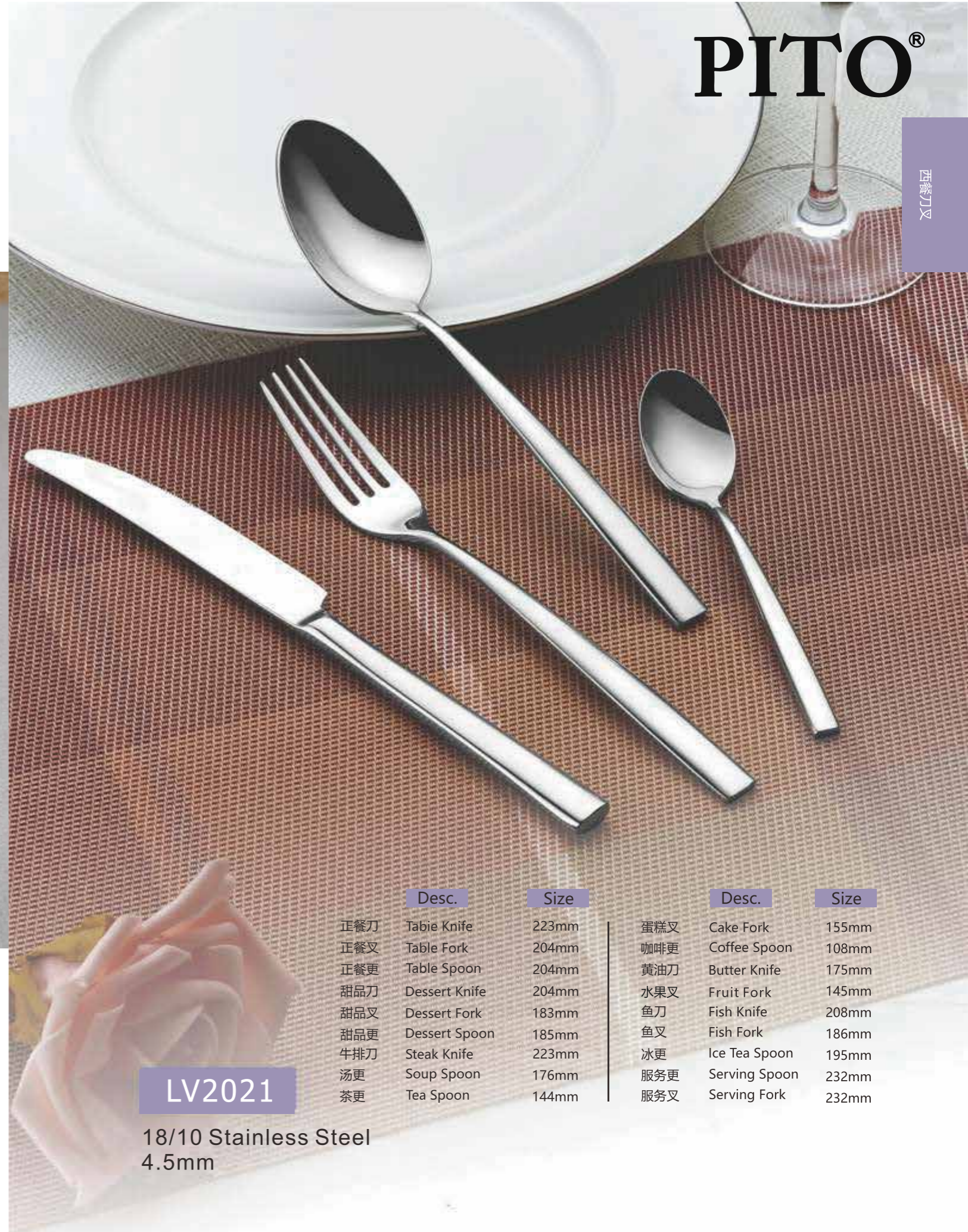

LV2021

18/10 Stainless Steel
4.5mm

Desc.	Size	Desc.	Size		
正餐刀	Table Knife	223mm	蛋糕叉	Cake Fork	155mm
正餐叉	Table Fork	204mm	咖啡更	Coffee Spoon	108mm
正餐更	Table Spoon	204mm	黄油刀	Butter Knife	175mm
甜品刀	Dessert Knife	204mm	水果叉	Fruit Fork	145mm
甜品叉	Dessert Fork	183mm	鱼刀	Fish Knife	208mm
甜品更	Dessert Spoon	185mm	鱼叉	Fish Fork	186mm
牛排刀	Steak Knife	223mm	冰更	Ice Tea Spoon	195mm
汤更	Soup Spoon	176mm	服务更	Serving Spoon	232mm
茶更	Tea Spoon	144mm	服务叉	Serving Fork	232mm



LV2037

18/10 Stainless Steel
4.5mm

	Desc.	Size
正餐刀	Table Knife	238mm
正餐叉	Table Fork	210mm
正餐更	Table Spoon	210mm
甜品刀	Dessert Knife	214mm
甜品叉	Dessert Fork	188mm
甜品更	Dessert Spoon	188mm
牛排刀	Steak Knife	238mm

	Desc.	Size
茶更	Tea Spoon	145mm
咖啡更	Coffee Spoon	118mm
黄油刀	Butter Knife	160mm
汤更	Soup Spoon	178mm
蛋糕叉	Cake Fork	146mm
服务叉	Serving Fork	240mm
服务更	Serving Spoon	240mm



LV2038

18/10 Stainless Steel
4.5mm

	Desc.	Size
正餐刀	Table Knife	238mm
正餐叉	Table Fork	210mm
正餐更	Table Spoon	210mm
甜品刀	Dessert Knife	214mm
甜品叉	Dessert Fork	188mm
甜品更	Dessert Spoon	188mm
牛排刀	Steak Knife	238mm

	Desc.	Size
汤更	Soup Spoon	178mm
蛋糕叉	Cake Fork	146mm
茶更	Tea Spoon	145mm
咖啡更	Coffee Spoon	118mm
黄油刀	Butter Knife	160mm
服务叉	Serving Fork	240mm
服务更	Serving Spoon	240mm

LV3103

18/10 Stainless Steel
3.5mm

	Desc.	Size		Desc.	Size
正餐刀	Table Knife	248mm	牛排刀	Steak Knife	232mm
正餐叉	Table Fork	207mm	汤更	Soup Spoon	182mm
正餐更	Table Spoon	207mm	蛋糕叉	Cake Fork	150mm
甜品刀	Dessert Knife	218mm	茶更	Tea Spoon	139mm
甜品叉	Dessert Fork	186mm	咖啡更	Coffee Spoon	105mm
甜品更	Dessert Spoon	185mm			



LV2034

18/10 Stainless Steel
6.0mm

	Desc.	Size		Desc.	Size
汤更	Soup Spoon	183mm	正餐刀	Table Knife	242mm
茶更	Tea Spoon	145mm	正餐叉	Table Fork	208mm
咖啡更	Coffee Spoon	120mm	正餐更	Table Spoon	210mm
黄油刀	Butter Knife	163mm	甜品刀	Dessert Knife	225mm
冰更	Ice Tea Spoon	185mm	甜品叉	Dessert Fork	188mm
鱼刀	Fish Knife	212mm	甜品更	Dessert Spoon	195mm
鱼叉	Fish Fork	193mm	牛排刀	Steak Knife	242mm
服务叉	Serving Fork	193mm	水果叉	Fruit Fork	156mm
服务更	Serving Spoon	261mm	蛋糕叉	Cake Fork	146mm

LV2025

18/10 Stainless Steel

3.5mm

	Desc.	Size		Desc.	Size
正餐刀	Table Knife	237mm	茶更	Tea Spoon	141mm
正餐叉	Table Fork	203mm	咖啡更	Coffee Spoon	111mm
正餐更	Table Spoon	200mm	水果叉	Fruit Fork	145mm
甜品刀	Dessert Knife	211mm	鱼刀	Fish Knife	207mm
甜品叉	Dessert Fork	185mm	鱼叉	Fish Fork	179mm
甜品更	Dessert Spoon	184mm	黄油刀	Butter Knife	170mm
牛排刀	Steak Knife	236mm	冰更	Ice Tea Spoon	190mm
汤更	Soup Spoon	177mm	服务更	Serving Spoon	199mm
蛋糕叉	Cake Fork	155mm			



LV2008B

18/10 stainless steel
5.0mm



LV2008

18/10 Stainless Steel

4.0mm

	Desc.	Size
正餐刀	Table Knife	250mm
正餐叉	Table Fork	215mm
正餐更	Table Spoon	218mm
甜品刀	Dessert Knife	228mm
甜品叉	Dessert Fork	191mm
甜品更	Dessert Spoon	194mm
牛排刀	Steak Knife	250mm
黄油刀	Butter Knife	178mm
咖啡更	Coffee Spoon	118mm
蛋糕叉	Cake Fork	152mm
冰更	Ice Tea Spoon	180mm
汤更	Soup Spoon	178mm
茶更	Tea Spoon	144mm
鱼刀	Fish Knife	235mm
鱼叉	Fish Fork	215mm
服务叉	Serving Fork	243mm
服务更	Serving Spoon	246mm



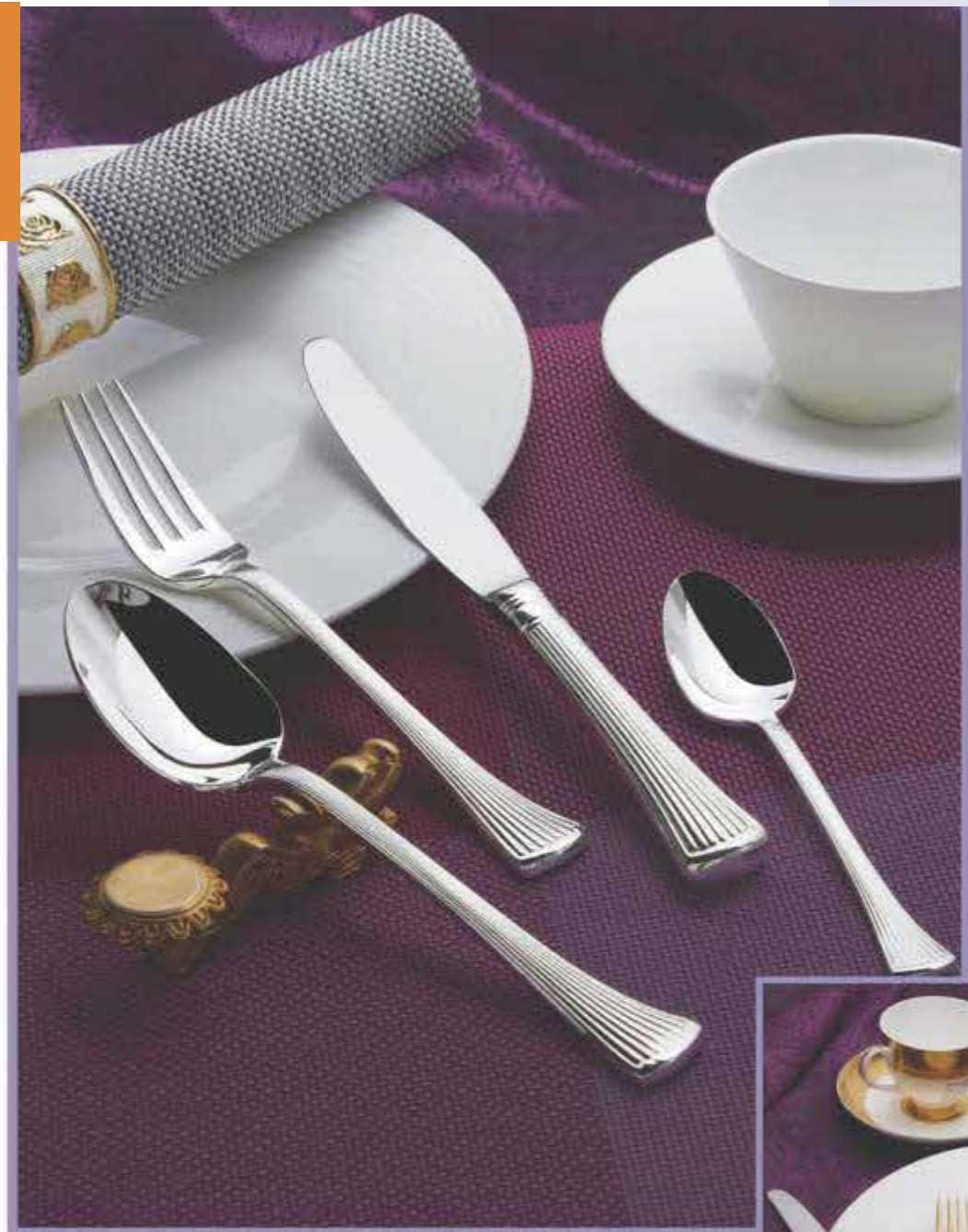

LV2002

18/10 Stainless Steel
5.0mm



	Desc.	Size
正餐刀	Table Knife	238mm
正餐叉	Table Fork	198mm
正餐更	Table Spoon	200mm
茶更	Tea Spoon	152mm
茶叉	Tea Fork	152mm

LV9004

18/10 Stainless Steel
15mm



LV2004

18/10 Stainless Steel
3.0mm

	Desc.	Size
正餐刀	Table Knife	240mm
正餐叉	Table Fork	200mm
正餐更	Table Spoon	200mm
茶更	Tea Spoon	160mm





LV9006

18/10 Stainless Steel
11.0mm

	Desc.	Size
正餐刀	Table Knife	245mm
正餐叉	Table Fork	210mm
正餐更	Table Spoon	210mm
茶更	Tea Spoon	160mm

LV9006G

18/10 Stainless Steel
11.0mm

	Desc.	Size
正餐刀	Table Knife	245mm
正餐叉	Table Fork	210mm
正餐更	Table Spoon	210mm
茶更	Tea Spoon	160mm



LV2209S

18/10 Stainless Steel
4.5mm

	Desc.	Size
正餐刀	Table Knife	231mm
正餐叉	Table Fork	223mm
正餐更	Table Spoon	227mm
甜品刀	Dessert Knife	217mm
甜品叉	Dessert Fork	205mm
甜品更	Dessert Spoon	204mm
牛排刀	Steak Knife	243mm
汤更	Soup Spoon	202mm
茶更	Tea Spoon	156mm
咖啡更	Coffee Spoon	120mm
蛋糕叉	Cake Fork	160mm

	Desc.	Size
水果叉	Fruit Fork	150mm
鱼刀	Fish Knife	237mm
鱼叉	Fish Fork	217mm
黄油刀	Butter Knife	168mm
冰更	Ice Tea Spoon	206mm
沙拉更	Salad Spoon	216mm
服务更	Serving spoon	228mm
分菜更	Divide The Spoon	224mm
大长更	Big long Spoon	280mm
漏更	Leak Spoon	280mm
蛋糕铲	Cake Server	270mm

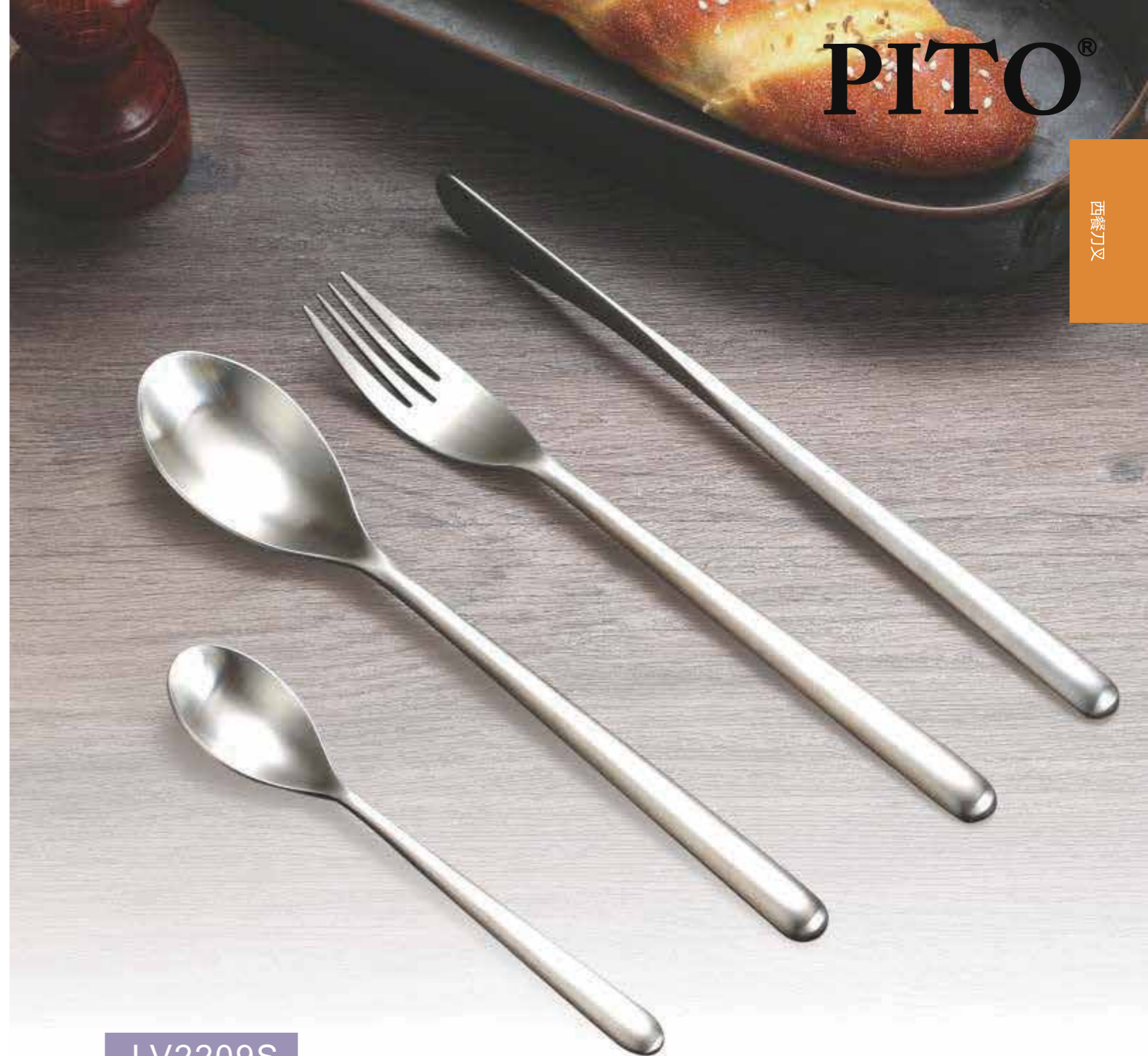

LV2011

18/10 Stainless Steel
3.5mm

Desc.	Size	Desc.	Size		
正餐刀	Table Knife	238mm	甜品更	Dessert Spoon	186mm
正餐叉	Table Fork	213mm	茶更	Tea Spoon	142mm
正餐更	Table Spoon	210mm	咖啡更	Coffee Spoon	112mm
甜品刀	Dessert Knife	213mm	汤更	Soup Spoon	176mm
甜品叉	Dessert Fork	184mm			



LV2010

18/10 Stainless Steel
3.5mm



Desc.	Size	
正餐刀	Table Knife	236mm
正餐叉	Table fork	203mm
正餐更	Table spoon	212mm
甜品刀	Dessert Knife	210mm
甜品叉	Dessert Fork	186mm
甜品更	Dessert Spoon	188mm
牛排刀	Steak Knife	235mm
汤更	Soup Spoon	172mm
茶更	Tea Spoon	155mm
咖啡更	coffee spoon	136mm
冰更	Ice tea Spoon	220mm
黄油刀	butter knife	168mm
莫卡更	mocha spoon	108.7mm



LV2013

18/10 Stainless Steel
3.5mm

Desc.	Size	
正餐刀	Table Knife	238mm
正餐叉	Table fork	204mm
正餐更	Table spoon	203mm
甜品刀	Dessert Knife	209mm
甜品叉	Dessert Fork	180mm
甜品更	Dessert Spoon	180mm
茶更	Tea Spoon	136mm
咖啡更	coffee spoon	118mm
蛋糕叉	Cake Fork	146mm





LV2024

18/10 Stainless Steel
5.0mm

Desc.	Size	Desc.	Size
正餐刀	Table Knife 244mm	汤更	Soup Spoon 182mm
正餐叉	Table fork 218mm	茶更	Tea Spoon 146mm
正餐更	Table spoon 218mm	蛋糕叉	Cake Fork 148mm
甜品刀	Dessert Knife 223mm	咖啡更	Coffee Spoon 114mm
甜品叉	Dessert Fork 189mm	黄油刀	Butter Knife 175mm
甜品更	Dessert Spoon 191mm	冰更	Ice Tea Spoon 211mm
牛排刀	Steak Knife 244mm		



LV3105

18/10 Stainless Steel
4.0mm

Desc.	Size	Desc.	Size
正餐刀	Table Knife 233mm	甜品更	Dessert Spoon 180mm
正餐叉	Table Fork 205mm	汤更	Soup Spoon 176mm
正餐更	Table Spoon 205mm	茶更	Tea Spoon 142mm
甜品叉	Dessert Fork 185mm	蛋糕叉	Cake Fork 145mm



LV3106

18/10 Stainless Steel
9.0mm

Desc.	Size
正餐刀	Table Knife 243mm
正餐叉	Table Fork 207mm
正餐更	Table Spoon 198mm
甜品刀	Dessert Knife 202mm
甜品叉	Dessert Fork 186mm
甜品更	Dessert Spoon 186mm

Desc.	Size
汤更	Soup Spoon 198mm
茶更	Tea Spoon 141mm
蛋糕叉	Cake Fork 141mm
咖啡更	Coffee Spoon 116mm
大提勺	Soup Ladle 292mm

LV3107

18/10 Stainless Steel
9.0mm

Desc.	Size
正餐刀	Table Knife 240mm
正餐叉	Table Fork 205mm
正餐更	Table Spoon 202mm
甜品刀	Dessert Knife 202mm
甜品叉	Dessert Fork 192mm
甜品更	Dessert Spoon 190mm
牛排刀	Steak Knife 240mm

Desc.	Size
汤更	Soup Spoon 186mm
糕点叉	Sweet Fork 175mm
糕点勺	Sweet Spoon 176mm
茶更	Tea Spoon 138mm
蛋糕叉	Cake Fork 141mm
咖啡更	Coffee Spoon 123mm



LV3108

18/10 Stainless Steel
5.0mm

主餐刀
主餐叉
主餐勺
甜品叉
甜品更
汤勺
茶勺
咖啡勺
点心勺

Desc.	Size
Table Knife	230mm
Table Fork	205mm
Table Spoon	203mm
Dessert Fork	189mm
Dessert Spoon	185mm
Soup Spoon	180mm
Tea Spoon	148mm
Coffee Spoon	118mm
Sweet Spoon	164mm



LV2027

18/10 Stainless Steel
3.5mm

	Desc.	Size		Desc.	Size
正餐刀	Table Knife	231mm	汤更	Soup Spoon	181mm
正餐叉	Table Fork	208mm	黄油刀	Butter Knife	182mm
正餐更	Table Spoon	210mm	茶勺	Tea Spoon	143mm
美式餐叉	American Fork	192mm	咖啡勺	Coffee Spoon	112mm
美式餐更	American Spoon	193mm	鱼刀	Fish Knife	209mm
甜品刀	Dessert Knife	207mm	鱼叉	Fish Fork	190mm
甜品叉	Dessert Fork	175mm	蛋糕叉	Cake Fork	145mm
甜品更	Dessert Spoon	175mm	服务更	Serving Spoon	235mm
牛排刀	Steak Knife	226mm			

CD0801

Stainless Steel
3.0mm

	Desc.	Size
正餐刀	Table Knife	237mm
正餐叉	Table Fork	208mm
正餐更	Table Spoon	210mm
甜品刀	Dessert Knife	209mm
甜品叉	Dessert Fork	180mm
甜品更	Dessert Spoon	186mm
汤更	Soup Spoon	177mm
茶更	Tea Spoon	140mm
蛋糕叉	Cake Fork	140mm
咖啡更	Coffee Spoon	127mm



LV2005

18/10 Stainless Steel
3.5mm

	Desc.	Size
正餐刀	Table Knife	255mm
正餐叉	Table Fork	214mm
正餐更	Table Spoon	214mm
茶更	Tea Spoon	140mm



CD0907

18/10 Stainless Steel
3.5mm

	Desc.	Size
正餐刀	Table Knife	240mm
正餐更	Table Fork	206mm
正餐叉	Table Spoon	208mm
甜品刀	Dessert Knife	204mm
甜品更	Dessert Fork	195mm
甜品叉	Dessert Spoon	195mm
牛排刀	Steak Knife	239mm



LV2005G

18/10 Stainless Steel
3.5mm

	Desc.	Size
正餐刀	Table Knife	255mm
正餐叉	Table Fork	214mm
正餐更	Table Spoon	214mm
茶更	Tea Spoon	140mm





LV051

Stainless Steel
5.0mm

Desc.	Size
正餐刀	Table Knife 232mm
正餐叉	Table Fork 206mm
正餐更	Table Spoon 209mm
甜品刀	Dessert Knife 218mm
甜品叉	Dessert Fork 183mm
甜品更	Dessert Spoon 187mm
牛排刀	Steak Knife 234mm
水果叉	Fruit Fork 142mm
蛋糕叉	Cake Fork 152mm

Desc.	Size
汤更	Soup Spoon 201mm
茶更	Tea Spoon 146mm
咖啡更	Coffee Spoon 120mm
黄油刀	Butter Knife 151mm
冰更	Ice Tea Spoon 204mm
鱼刀	Fish Knife 227mm
鱼叉	Fish Fork 210mm
服务叉	Serving Fork 243mm
服务更	Serving Spoon 246mm



CD0902

Stainless Steel
5.0mm

	Desc.	Size
正餐刀	Table Knife	223mm
正餐叉	Table Fork	209mm
正餐更	Table Spoon	213mm
甜品刀	Dessert Knife	195mm
甜品叉	Dessert Fork	191mm
甜品更	Dessert Spoon	198mm
汤更	Soup Spoon	193mm
茶更	Tea Spoon	147mm
咖啡更	Coffee Spoon	126mm

CD0906

Stainless Steel
3.5mm

	Desc.	Size
正餐刀	Table Knife	225mm
正餐叉	Table Fork	205mm
正餐更	Table Spoon	205mm
甜品刀	Dessert Knife	200mm
甜品叉	Dessert Fork	180mm
甜品更	Dessert Spoon	185mm
牛排刀	Steak Knife	225mm
水果叉	Fruit Fork	140mm
蛋糕叉	Cake Fork	140mm
1#汤更	1#Soup Spoon	200mm
2#汤更	2#Soup Spoon	180mm
茶更	Tea Spoon	145mm
咖啡更	Coffee Spoon	120mm
冰更	Ice Tea Spoon	198mm
蛋糕铲	Cake Server	255mm
鱼刀	Fish Knife	195mm
鱼叉	Fish Fork	185mm
沙拉叉	Salad Fork	210mm
沙拉更	Salad Spoon	205mm
服务叉	Serving Fork	250m
服务更	Serving Spoon	248mm



LV083

Stainless Steel
3.0mm



	Desc.	Size
正餐刀	Table Knife	231mm
正餐叉	Table Fork	201mm
正餐更	Table Spoon	178mm
甜品刀	Dessert Knife	207mm
甜品叉	Dessert Fork	183mm
甜品更	Dessert Spoon	179mm
牛排刀	Steak Knife	232mm
汤更	Soup Spoon	187mm
茶更	Tea Spoon	137mm
咖啡更	coffee Spoon	121mm

	Desc.	Size
蛋糕叉	Cake Fork	145mm
水果叉	Fruit Fork	150mm
冰更	Ice Tea Spoon	171mm
鱼刀	Fish Knife	213mm
鱼叉	Fish Fork	204mm
黄油刀	Butter Knife	152mm
分菜更	Serving Spoon	192mm
雪糕勺	Ice Cream Spoon	137mm
沙拉叉	Salad Fork	202mm
沙拉更	Salad Spoon	195mm

CN318

Stainless Steel
7.0mm

	Desc.	Size		Desc.	Size
正餐刀	Table Knife	235mm	水果叉	Fruit Fork	140mm
正餐叉	Table Fork	205mm	雪糕更	Ice Cream Spoon	135mm
正餐更	Table Spoon	203mm	冰更	Ice Tea Spoon	210mm
甜品刀	Dessert Knife	205mm	黄油刀	Butter Knie	162mm
甜品叉	Dessert Fork	177mm	蛋糕铲	Cake Server	242mm
甜品更	Dessert Spoon	175mm	鱼刀	Fish Knife	208mm
牛排刀	Steak Knife	235mm	鱼叉	Fish Fork	208mm
汤更	Soup Spoon	190mm	服务更	Serving Spoon	214mm
茶更	Tea Spoon	140mm	服务叉	Serving Fork	216mm
咖啡更	Coffee Spoon	112mm	小提勺	Gravy Ladle	176mm
蛋糕叉	Cake Fork	147mm	大提勺	Soup Ladle	330mm



	Desc.	Size
正餐叉	Table Fork	214mm
正餐刀	Table Knife	230mm
正餐更	Table Spoon	215mm
甜品叉	Dessert Fork	182mm
甜品刀	Dessert Knife	198mm
甜品更	Dessert Spoon	174mm
牛排刀	Steak Knife	236mm
汤更	Soup Spoon	199mm
茶更	Tea Spoon	144mm

	Desc.	Size
蛋糕叉	Cake Fork	146mm
水果叉	Fruit Fork	117mm
咖啡更	Coffee Spoon	120mm
冰更	Ice Tea Spoon	226mm
黄油刀	Butter Knife	154mm
鱼叉	Fish Fork	183mm
鱼刀	Fish Knife	189mm
服务更	Serving Spoon	246mm
服务叉	Serving Fork	246mm

CN030

Stainless Steel 7.0mm



LV066

Stainless Steel 5.5mm

	Desc.	Size
正餐刀	Table Knife	242mm
正餐更	Table Spoon	218mm
正餐叉	Table Fprk	217mm
甜品刀	Dessert Knife	200mm
甜品叉	Dessert Fork	195mm
甜品更	Dessert Spoon	214mm
牛排刀	Steak Knife	247mm
汤更	Soup Spoon	207mm
茶更	Tea Spoon	156mm
咖啡更	Coffee Spoon	121mm
水果叉	Fruit Fork	162mm

	Desc.	Size
蛋糕叉	Cake Fork	160mm
冰更	Ice Tea Spoon	200mm
雪糕更	Ice Cream Spoon	150mm
黄油刀	Butter Knie	164mm
鱼刀	Fish Knife	235mm
鱼叉	Fish Fork	220mm
分菜更	Serving Spoon	218mm
沙拉更	Salad Spoon	215mm
沙拉叉	Salad Fork	215mm
服务叉	Serving Fork	226mm
服务更	Serving Spoon	226mm



LV005

Stainless Steel
4.0mm

	Desc.	Size
正餐刀	Table Knife	237mm
正餐叉	Table Fork	209mm
正餐更	Table Spoon	200mm
甜品刀	Dessert Knife	208mm
甜品叉	Dessert Fork	182mm
甜品更	Dessert Spoon	180mm
牛排刀	Steak Knife	233mm
汤更	Soup Spoon	193mm
鱼刀	Fish Knife	224mm
鱼叉	Fish Fork	210mm
黄油刀	Butter Knife	159mm
茶更	Tea Spoon	147mm
咖啡更	Coffee Spoon	114mm
蛋糕叉	Cake Fork	154mm
水果叉	Fruit Fork	155mm
冰更	Ice Tea Spoon	194mm
雪糕勺	Ice-cream Spoon	144mm
糖勺	Sugar Spoon	144mm
沙律叉	Salad Fork	202mm
沙律叉	Salad Spoon	202mm
分菜更	Divide The Spoon	208mm
服务更	Serving Spoon	213mm
服务叉	Serving Fork	215mm



CD0901

Stainless Steel
5.0mm

	Desc.	Size
餐刀	Table Knife	235mm
餐叉	Table Fork	201mm
餐勺	Table Spoon	200mm
茶勺	Tea Spoon	147mm
茶叉	Tea Fork	147mm
咖啡更	Coffee Spoon	129mm
汤更	Soup Spoon	192mm
牛排刀	Steak Knife	236mm
甜品刀	Dessert Knife	175mm
甜品叉	Dessert Fork	175mm
甜品更	Dessert Spoon	210mm



LV082

Stainless Steel
3.0mm



正餐刀	Table Knife	225mm
正餐更	Table Spoon	203mm
正餐叉	Table Fprk	203mm
甜品更	Dessert Spoon	198mm
甜品叉	Dessert Fork	185mm
甜品刀	Dessert Knife	184mm
尖茶更	O.Tea Spoon	163mm
圆茶更	R.Tea Spoon	150mm
蛋糕叉	Cake Fork	134mm
尖咖啡更	O.Coffee Spoon	132mm
圆咖啡更	R.Coffee Spoon	121mm
茶叉	Tea Fork	161mm
尖摩卡更	O.Mocha Spoon	113mm
圆摩卡更	R.Mocha Spoon	106mm
水果叉	Fruit Fork	118mm
糖夹	Sugar Tong	110mm
尖冰更	O.Ice Tea Spoon	185mm
圆冰更	R.Ice Tea Spoon	171mm
1#汤更	1#Soup Spoon	190mm
2#汤更	2#Soup Spoon	168mm
牛排刀	Steak Knife	221mm
肉叉	Meat Fork	160mm
鱼刀	Fish Knife	208mm
黄油刀	Butter Knie	168mm
沙拉叉	Salad Fork	185mm
沙拉更	Salad Spoon	185mm

1#服务更	1#Serving Spoon	250mm
1#服务叉	1#Serving Fork	240mm
小提勺	Gravy Ladle	240mm
2#服务更	2#Serving Spoon	206mm
2#服务叉	2#Serving Fork	213mm
雪糕勺	Ice Cream Spoon	135mm
糖更	Sugar Spoon	129mm

LV092

Stainless Steel
3.0mm



LV096-1

18/10 Stainless Steel
5.0mm

	Desc.	Size
正餐刀	Table Knife	236mm
正餐叉	Table Fork	207mm
正餐更	Table Spoon	210mm
甜品刀	Dessert Knife	241mm
甜品叉	Dessert Spoon	195mm
甜品更	Dessert Fork	190mm
牛排刀	Steak Knife	237mm
汤更	Soup Spoon	195mm

	Desc.	Size
茶更	Tea Spoon	145mm
咖啡更	Coffee Spoon	115mm
蛋糕叉	Cake Fork	120mm
水果叉	Fruit Fork	115mm
黄油刀	Butter Knife	175mm
服务更	Serving Spoon	211mm

LV098

Stainless Steel
3.0mm

	Desc.	Size
正餐刀	Table Knife	232mm
正餐叉	Table Fork	210mm
正餐更	Table Spoon	202mm
甜品刀	Dessert Knife	218mm
甜品叉	Dessert Fork	195mm
甜品更	Dessert Spoon	195mm
牛排刀	Steak Knife	231mm
汤更#1	Soup Spoon#1	196mm
汤更#2	Soup Spoon#2	186mm
茶更	Tea Spoon	146mm
茶叉	Tea Fork	155mm
肉叉	Meat Fork	150mm

	Desc.	Size
冰更#1	Ice Tea Spoon#1	198mm
冰更#2	Ice Tea Spoon#2	172mm
咖啡更#1	Coffee Spoon#1	133mm
咖啡更#2	Coffee Spoon#2	128mm
蛋糕叉	Cake Fork	136mm
莫卡更#1	Mocha Spoon#1	115mm
莫卡更#2	Mocha Spoon#2	110mm
水果叉	Fruit Fork	125mm
黄油刀	Butter Knife	153mm
雪糕更	Ice Cream Spoon	136mm
服务更	Serving Spoon	215mm



LV081

Stainless Steel
2.5mm

	Desc.	Size
正餐刀	Table Knife	245mm
正餐叉	Table Fork	215mm
正餐更	Table Spoon	205mm
甜品刀	Dessert Knife	227mm
甜品叉	Dessert Fork	185mm
甜品更	Dessert Spoon	180mm
牛排刀	Steak Knife	235mm
汤更	Soup Spoon	188mm
茶更	Tea Spoon	142mm
咖啡更	Coffee Spoon	111mm
蛋糕叉	Cake Fork	148mm

	Desc.	Size
水果叉	Fruit Fork	150mm
冰更	Ice Tea Spoon	131mm
黄油刀	Butter Knife	151mm
鱼刀	Fish Knife	217mm
鱼叉	Fish Fork	204mm
雪糕勺	Ice Cream Spoom	136mm
糖更	Sugar Spoon	134mm
服务更	Serving Spoon	205mm
沙拉叉	Salad Fork	212mm
沙拉更	Salad Spoon	212mm



CD0706

Stainless Steel
2.5mm

	Desc.	Size
正餐刀	Table Knife	231mm
正餐叉	Table Fork	206mm
正餐更	Table Spoon	203mm
甜品更	Dessert Spoon	182mm
甜品叉	Dessert Fork	188mm
茶更	Tea Spoon	145mm
茶叉	Tea Fork	148mm
咖啡更	Coffee Spoon	116mm
冰更	Ice Tea Spoon	194mm
牛排刀	Steak Knife	233mm

CD0702

Stainless Steel
2.5mm

	Desc.	Size
正餐刀	Table Knife	163mm
正餐叉	Table Fork	228mm
正餐更	Table Spoon	207mm
甜品刀	Dessert Knife	207mm
甜品叉	Dessert Fork	168mm
甜品更	Dessert Spoon	168mm
汤更	Soup Spoon	177mm
茶更	Tea Spoon	128mm
蛋糕叉	Cake Fork	128mm
冰更	Ice Tea Spoon	194mm



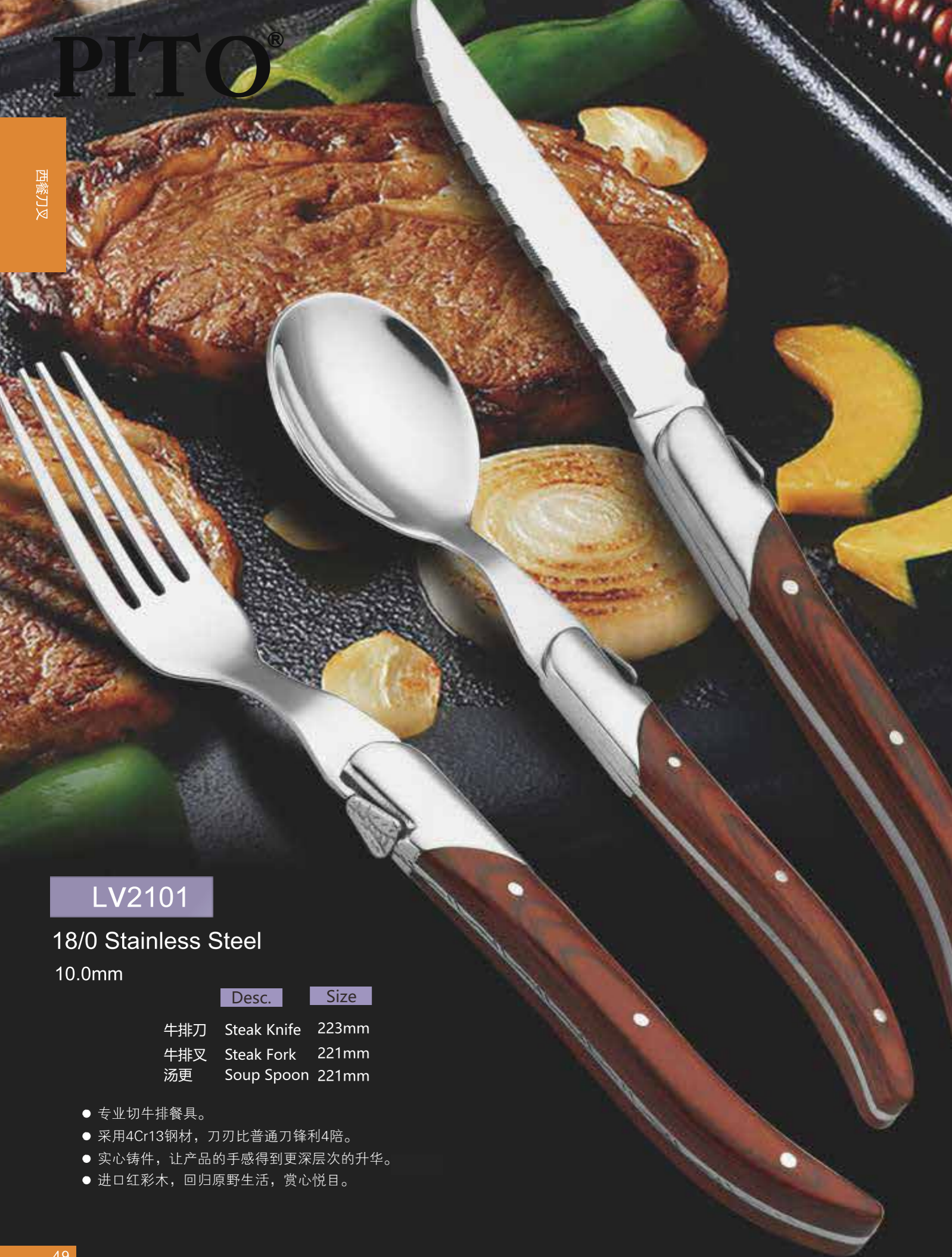

LV2101

18/0 Stainless Steel

10.0mm

	Desc.	Size
牛排刀	Steak Knife	223mm
牛排叉	Steak Fork	221mm
汤更	Soup Spoon	221mm

- 专业切牛排餐具。
- 采用4Cr13钢材，刀刃比普通刀锋利4倍。
- 实心铸件，让产品的手感得到更深层次的升华。
- 进口红彩木，回归原野生活，赏心悦目。



LV2102

18/10 Stainless Steel

10.0mm

	Desc.	Size
牛扒刀	Steak Knife	223mm
牛扒叉	Steak Fork	221mm
汤更	Soup Spoon	221mm

- 专业切牛排餐具。
- 采用4Cr13钢材，刀刃比普通刀锋利4倍。
- 实心铸件，让产品的手感得到更深层次的升华。
- 进口斑马木，与不锈钢结合，使生活绚丽多彩。



LV2103

Stainless Steel
10.0mm

	Desc.	Size
烧烤牛扒刀	Steak Knife Carving	298mm
烧烤牛扒叉	Steak Fork Carving	280mm

对生活的用心，于平凡中感受美，
浪漫而不繁缛典雅而不粗俗，
在自然流畅的纹理中悠扬飞扬



LV2105

18/10 Stainless Steel
10.0mm

	Desc.	Size
牛扒刀	Steak Knife	225mm
牛扒叉	Steak Fork	220mm
汤更	Soup Spoon	225mm

LV2104

18/10 Stainless Steel
10.0mm

	Desc.	Size
牛扒刀	Steak Knife	225mm
牛扒叉	Steak Fork	225mm



千锤百炼-精益求精

以优良的品质，颜值爆表的设计
满足您对生活品质的追求!



LV2108-1 (S/S) LV2108 (S/S)

- 锋利锯齿，轻松切割
- 德国钼钒钢，持久锋利
- 大斜角，握感舒适
- 实心锻造 厚重沉稳



LV2105 LV2101W LV2101L LV2101



LV2102B LV2102 LV2102R LV2107Z LV2107B

Desc.

美式牛排刀 (黄金彩木)
美式牛排刀 (黑彩木)
牛排刀 (黑彩木)
牛排刀 (红彩木)
牛排刀 (白珍珠)
牛排刀 (蓝晶)
牛排刀 (铸钢)
牛排刀 (铸钢)

Desc.

Steak Knife
Steak Knife
Steak Knife
Steak Knife
Steak Knife
Steak Knife
Steak Knife
Steak Knife

Size

223mm
223mm
223mm
223mm
223mm
223mm
223mm
223mm



LV2106

Stainless Steel 5.0mm

正餐刀
正餐叉
正餐更
茶更

Desc.

Table Knife
Table Fork
Table Spoon
Tea Spoon

Size

227mm
207mm
207mm
155mm



LV3104

18/10 Stainless Steel
3.0mm

	Desc.	Size
星钻牛排刀	Steak Knife	233mm
星钻正餐叉	Table Spoon	203mm
星钻正餐更	Table Fork	203cm
星钻茶更	Taa Fork	145mm
星钻茶叉	Tea Spoon	144mm
星钻甜品叉	Dessert Spoon	185mm
星钻甜品更	Dessert Fork	185mm

LV3104G

18/10 Stainless Steel
3.0mm

	Desc.	Size
星钻牛排刀	Steak Knife	233mm
星钻正餐叉	Table Spoon	203mm
星钻正餐更	Table Fork	203cm
星钻茶更	Taa Fork	145mm
星钻茶叉	Tea Spoon	144mm
星钻甜品叉	Dessert Spoon	185mm
星钻甜品更	Dessert Fork	185mm



LV9010

18/10 Stainless Steel
3.0mm

	Desc.	Size
正餐刀	Table Knife	180mm
正餐叉	Table Fork	165mm
正餐更	Table Spoon	165mm

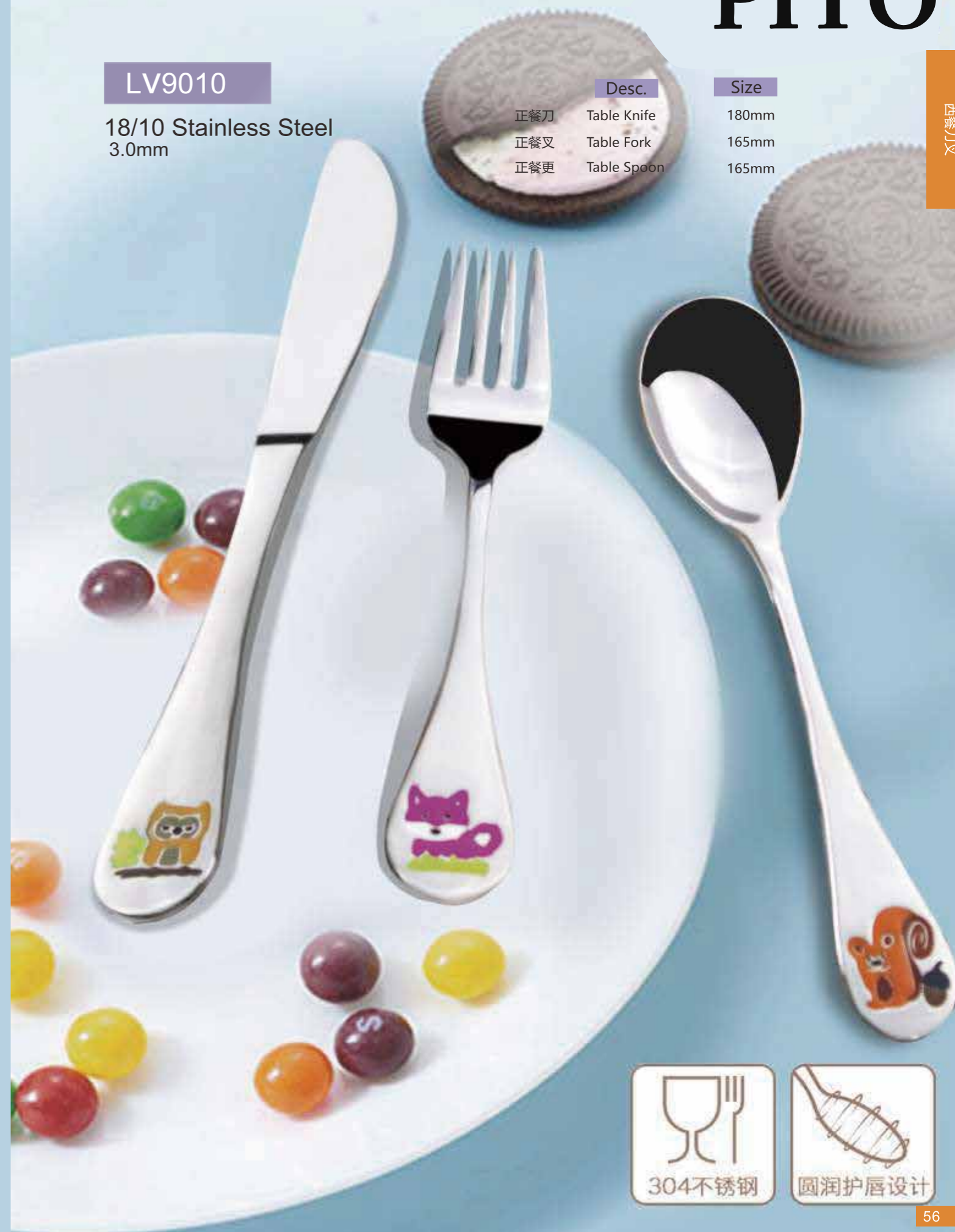



LV9008

Stainless Steel
Sun Angel

	Desc.	Size
正餐刀	Table Knife	170mm
正餐叉	Table Fork	154mm
正餐更	Table Spoon	137mm



LV9009

18/10 Stainless Steel
3.0mm 可定制图案

You Can Laser Engraving The Cartoon Pattern You Want

	Desc.	Size
正餐刀	Table Knife	170mm
正餐叉	Table Fork	155mm
正餐更	Table Spoon	155mm
茶更	Tae Spoon	130mm





LV2215

18/10 Stainless Steel
5.0mm

	Desc.	Size
正餐刀	Table Knife	232mm
正餐叉	Table Fork	213mm
正餐更	Table Spoon	214mm
甜品刀	Dessert Knife	208mm
甜品叉	Dessert Fork	178mm
甜品更	Dessert Spoon	181mm
汤更	Soup Spoon	196mm
咖啡更	Coffee Spoon	125mm
水果叉	Fruit Fork	156mm
蛋糕叉	Cake Fork	154mm
茶更	Tea Spoon	157mm



LV2215BG

18/10 Stainless Steel
5.0mm



LV2215G

18/10 Stainless Steel
5.0mm

LV2215M

18/10 Stainless Steel
5.0mm



LV006QF

18/10 Stainless Steel
6.0mm



	Desc.	Size
正餐刀	Table Knife	238mm
正餐叉	Table Fork	205mm
正餐更	Table Spoon	205mm
甜品刀	Dessert Knife	210mm
甜品叉	Dessert Fork	180mm
甜品更	Dessert Spoon	180mm
汤更	Soup Spoon	188mm
牛排刀	Steak Knife	242mm
二号汤更	#2 Soup Spoon	165mm
水果叉	Fruit Fork	142mm
蛋糕叉	Cake Fork	150mm

	Desc.	Size
茶更	Tea Spoon	145mm
鱼叉	Fish Fork	206mm
鱼刀	Fish Knife	220mm
咖啡更	Coffee Spoon	110mm
黄油刀	Butter Knife	178mm
冰更	Ice Tea Spoon	220mm
小提勺	Gravy Ladle	230mm
大提勺	Soup Ladle	320mm
蛋糕铲	Cake Server	250mm
服务更	Serving Spoon	240mm
服务叉	Serving Fork	240mm

LV006QS

18/10 Stainless Steel
6.0mm

西餐刀叉



	Desc.	Size
正餐刀	Table Knife	238mm
正餐叉	Table Fork	205mm
正餐更	Table Spoon	205mm
甜品刀	Dessert Knife	210mm
甜品叉	Dessert Fork	180mm
甜品更	Dessert Spoon	180mm
汤更	Soup Spoon	188mm
牛排刀	Steak Knife	242mm
二号汤更	#2 Soup Spoon	165mm
水果叉	Fruit Fork	142mm
蛋糕叉	Cake Fork	150mm

	Desc.	Size
茶更	Tea Spoon	145mm
鱼叉	Fish Fork	206mm
鱼刀	Fish Knife	220mm
咖啡更	Coffee Spoon	110mm
黄油刀	Butter Knife	178mm
冰更	Ice Tea Spoon	220mm
小提勺	Gravy Ladle	230mm
大提勺	Soup Ladle	320mm
蛋糕铲	Cake Server	250mm
服务更	Serving Spoon	240mm
服务叉	Serving Fork	240mm

西餐刀叉

LV2021QF

18/10 Stainless Steel
4.0mm

	Desc	Size
餐叉	Table Fork	204mm
餐勺	Table Spoon	204mm
筷子	Chopsticks	235mm



LV2021QS

18/10 Stainless Steel
4.0mm

	Desc	Size
餐叉	Table Fork	204mm
餐勺	Table Spoon	204mm
筷子	Chopsticks	235mm



LV2207

18/10 Stainless Steel
6.0mm

	Desc	Size		Desc	Size
正餐刀	Table Knife	232mm	甜点更	Tea Spoon	152mm
正餐叉	Table Fork	202mm	甜品叉	Cake Fork	147mm
正餐更	Table Spoon	197mm	水果叉	Fruit Fork	147mm
汤更	Soup Spoon	187mm			



LV2207VG

18/10 Stainless Steel
6.0mm



LV2207LG

18/10 Stainless Steel
6.0mm



LV2207BG

18/10 Stainless Steel
6.0mm

	Desc.	Size
正餐刀	Table Knife	232mm
正餐叉	Table Fork	202mm
正餐更	Table Spoon	197mm
汤更	Soup Spoon	187mm
甜品叉	Dessert Fork	152mm
甜品更	Dessert Spoon	147mm
水果叉	Fruit Fork	147mm





LV2003G

18/10 Stainless Steel
4.0mm

Desc.	Size	Desc.	Size		
正餐刀	Table Knife	244mm	茶更	Tea Spoon	142mm
正餐叉	Table Fork	211mm	咖啡更	Coffee Spoon	114mm
正餐更	Table Spoon	211mm	蛋糕叉	Cake Fork	158mm
甜品刀	Dessert Knife	224mm	黄油刀	Butter Knife	208mm
甜品叉	Dessert Fork	190mm	鱼刀	Fish Knife	204mm
甜品更	Dessert Spoon	190mm	鱼叉	Fish Fork	190mm
汤更	Soup Spoon	179mm			

备注：镀金产品有少量存，量多时按单生产，货期1周。



LV2026G

18/10 Stainless Steel
4.0mm

LV2026G-1

18/10 Stainless Steel
4.0mm

	Desc.	Size
正餐刀	Table Knife	243mm
正餐叉	Table Fork	202mm
正餐更	Table Spoon	211mm
甜品刀	Dessert Knife	224mm
甜品叉	Dessert Fork	188mm
甜品更	Dessert Spoon	190mm
牛排刀	Steak Knife	243mm
汤更	Soup Spoon	177mm
茶更	Tea Spoon	142mm
咖啡更	Coffee Spoon	114mm
蛋糕叉	Cake Fork	158mm
鱼刀	Fish Knife	208mm
鱼叉	Fish Fork	190mm
黄油刀	Butter Knife	174mm



LV006BS

18/10 Stainless Steel
5.0mm

	Desc.	Size		Desc.	Size
正餐刀	Table Knife	235mm	咖啡更	Coffee Spoon	110mm
正餐叉	Table Fork	201mm	黄油刀	Butter Knife	178mm
正餐更	Table Spoon	203mm	冰更	Ice Tea Spoon	213mm
甜品刀	Dessert Knife	207mm	鱼刀	Fish Knife	204mm
甜品叉	Dessert Fork	178mm	鱼叉	Fish Fork	202mm
甜品更	Dessert Spoon	175mm	蛋糕铲	Cake Server	247mm
牛排刀	Steak Knife	242mm	小提勺	Gravy Ladle	228mm
汤更	Soup Spoon	188mm	大提勺	Soup Ladle	300mm
茶更	Tea Spoon	145mm	服务更	Serving Spoon	240mm
蛋糕叉	Cake Fork	150mm	服务叉	Serving Fork	240mm
水果叉	Fruit Fork	140mm	二号汤更	2# Soup Spoon	167mm

备注：镀金产品有少量库存，量多时按单生产，货期1周。



LV006S

18/10 Stainless Steel
5.0mm

	Desc.	Size		Desc.	Size
正餐刀	Table Knife	235mm	咖啡更	Coffee Spoon	110mm
正餐叉	Table Fork	201mm	黄油刀	Butter Knife	178mm
正餐更	Table Spoon	203mm	冰更	Ice Tea Spoon	213mm
甜品刀	Dessert Knife	207mm	鱼刀	Fish Knife	204mm
甜品叉	Dessert Fork	178mm	鱼叉	Fish Fork	202mm
甜品更	Dessert Spoon	175mm	蛋糕铲	Cake Server	247mm
牛排刀	Steak Knife	242mm	小提勺	Gravy Ladle	228mm
汤更	Soup Spoon	188mm	大提勺	Soup Ladle	300mm
茶更	Tea Spoon	145mm	服务更	Serving Spoon	240mm
蛋糕叉	Cake Fork	150mm	服务叉	Serving Fork	240mm
水果叉	Fruit Fork	140mm	二号汤更	2# Soup Spoon	167mm





LV9005B

Stainless Steel
3.5mm

Desc.	Size	Desc.	Size		
正餐刀	Table Knife	230mm	茶更	Tea Spoon	133mm
正餐叉	Table Fork	203mm	冰更	Ice Tea Spoon	206mm
正餐更	Table Spoon	203mm	咖啡更	Coffee Spoon	119mm
甜品刀	Dessert Knife	213mm	黄油刀	Butter Knife	146mm
甜品叉	Dessert Fork	185mm	鱼刀	Fish Knife	203mm
甜品更	Dessert Spoon	185mm	鱼叉	Fish Fork	186mm
牛排刀	Steak Knife	218mm	雪糕更	Ice Cream Spoon	125mm
汤更	Soup Spoon	175mm	服务更	Serving Spoon	241mm
水果叉	Fruit Fork	145mm	服务叉	Serving Fork	247mm
蛋糕叉	Cake Fork	136mm			



LV9005G

18/10 Stainless Steel
4.0mm

Desc.	Size	Desc.	Size		
正餐刀	Table Knife	230mm	黄油刀	Butter Knife	145mm
正餐叉	Table Fork	204mm	茶更	Tea Spoon	133mm
正餐更	Table Spoon	202mm	咖啡更	Coffee Spoon	119mm
甜品刀	Dessert Knife	215mm	蛋糕叉	Cake Fork	138mm
甜品叉	Dessert Fork	185mm	水果叉	Fruit Fork	143mm
甜品更	Dessert Spoon	185mm	雪糕更	Ice-cream Spoon	125mm
牛排刀	Steak Knife	217mm	冰更	Ice Tea Spoon	206mm
汤更	Soup Spoon	175mm	服务更	Serving Spoon	242mm
鱼刀	Fish Knife	202mm	服务叉	Serving Fork	247mm
鱼叉	Fish Fork	186mm			



Desc.	Size
-------	------

正餐刀	Table Knife	245mm
正餐叉	Table Fork	212mm
正餐更	Table Spoon	214mm
甜品刀	Dessert Knife	218mm
甜品叉	Dessert Fork	193mm
甜品更	Dessert Spoon	193mm
牛排刀	Steak Knife	245mm
汤更	Soup Spoon	184mm

Desc.	Size
-------	------

咖啡更	Coffee Spoon	115mm
黄油刀	Butter Knife	183mm
蛋糕叉	Cake Fork	147mm
水果叉	Fruit Fork	147mm
服务更	Serving Spoon	260mm
漏餐更	PCB Spoon	257mm
鱼刀	Fish Knife	181mm
鱼叉	Fish Fork	183mm

LV2012G

18/10 Stainless Steel
5.0mm

LV2012BG

18/10 Stainless Steel
5.0mm

The modirlling of lelegant, soft tactily,
beautiful make all comfortable, natural, yesteday's glory,
wireless in your gets today's classical fashion





LV2202S

18/10 Stainless Steel
6.0mm

Desc.	Size	Desc.	Size		
正餐刀	Table Knife	225mm	茶更	Tea Spoon	147mm
正餐叉	Table Fork	198mm	咖啡更	Coffee Spoon	134mm
正餐更	Table Spoon	195mm	蛋糕叉	Cake Fork	144mm
甜品刀	Dessert Knife	203mm	水果叉	Fruit Fork	203mm
甜品叉	Dessert Fork	183mm	冰更	Ice Tea Spoon	143mm
甜品更	Dessert Spoon	181mm	筷子	Chopsticks	235mm
牛排刀	Steak Knife	223mm	黄油刀	Butter Knife	162mm

LV2202BS

18/10 Stainless Steel
6.0mm



Desc.	Size	
正餐刀	Table Knife	222mm
正餐叉	Table Fork	198mm
正餐更	Table Spoon	195mm
甜品刀	Dessert Knife	203mm
甜品叉	Dessert Fork	183mm
甜品更	Dessert Spoon	181mm
牛排刀	Steak Knife	223mm
茶更	Tea Spoon	147mm
咖啡更	Coffee Spoon	134mm
蛋糕叉	Cake Fork	144mm
水果叉	Fruit Fork	203mm
冰更	Ice Tea Spoon	143mm
筷子	Chopsticks	235mm
黄油刀	Butter Knife	162mm

LV2202G

18/10 Stainless Steel
6.0mm



备注：镀钛金、玫瑰金、PVD黑、彩金，货期1周。

LV2201

18/10 Stainless Steel
5.0mm

	Desc.	Size		Desc.	Size
正餐刀	Table Knife	221mm	茶更	Tea Spoon	126mm
正餐叉	Table Fork	217mm	蛋糕叉	Cake Fork	125mm
正餐更	Table Spoon	211mm	冰更	Ice Tea Spoon	195mm
甜品刀	Dessert Knife	200mm			
甜品更	Dessert Spoon	180mm			
甜品叉	Dessert Fork	180mm			



LV2201BS

18/10 Stainless Steel
5.0mm

	Desc.	Size
正餐刀	Table Knife	221mm
正餐叉	Table Fork	217mm
正餐更	Table Spoon	211mm
甜品刀	Dessert Knife	200mm
甜品更	Dessert Spoon	180mm
甜品叉	Dessert Fork	180mm
茶更	Tea Spoon	126mm
蛋糕叉	Cake Fork	125mm
冰更	Ice Tea Spoon	195mm





LV2201BM

18/10 Stainless Steel
5.0mm

LV2201BG

18/10 Stainless Steel
5.0mm

	Desc.	Size
正餐刀	Table Knife	221mm
正餐叉	Table Fork	217mm
正餐更	Table Spoon	211mm
甜品刀	Dessert Knife	200mm
甜品更	Dessert Spoon	180mm
甜品叉	Dessert Fork	180mm
茶更	Tea Spoon	126mm
蛋糕叉	Cake Fork	125mm
冰更	Ice Tea Spoon	195mm



LV2201RG

18/10 Stainless Steel
5.0mm

LV2201B

18/10 Stainless Steel
5.0mm



LV2201WG

18/10 Stainless Steel
5.0mm



LV2201G

18/10 Stainless Steel
5.0mm





LV2221

18/10 Stainless Steel
5.0mm



LV2220

18/10 Stainless Steel
5.0mm



LV2219

18/10 Stainless Steel
5.0mm

	Desc.	Size
正餐刀	Table Knife	218mm
正餐叉	Table Fork	206mm
正餐更	Table Spoon	197mm
茶更	Tea Spoon	146mm
茶叉	Tea Fork	150mm



LV2218J

18/10 Stainless Steel
5.0mm

LV2218G

18/10 Stainless Steel
5.0mm

	Desc.	Size
正餐刀	Table Knife	230mm
正餐更	Table Spoon	207mm
正餐叉	Table Fork	214mm
甜品刀	Dessert Knife	200mm
甜品更	Dessert Fork	181mm
甜品叉	Dessert Spoon	187mm
尖茶更	O.Tea Spoon	125mm
圆茶更	R.Tea Spoon	131mm
汤更#1	Soup Spoon#1	216mm
汤更#2	Soup Spoon#2	189mm
水果叉	Fruit Fork	140mm
长水果叉	Big Fruit Fork	210mm
圆冰更	R.Ice Tea Spoon	202mm
尖冰更	O.Ice Tea Spoon	200mm





LV2210

18/10 Stainless Steel
5.0mm

	Desc.	Size
正餐刀	Table knife	212mm
正餐叉	Table fork	200mm
正餐更	Table spoon	199mm
甜品刀	Dessert Knife	201mm
甜品叉	Dessert Fork	190mm
甜品更	Dessert Spoon	189mm
牛排刀	Steak Knife	219mm
汤更	Soup Spoon	185mm
冰更	Ice Tea Spoon	205mm
茶更	Tea spoon	140mm
咖啡更	Coffee spoon	130mm
黄油刀	Butter Knife	162mm
蛋糕叉	Cake Fork	151mm
水果叉	Fruit fork	136mm
分菜更	Divide vegetables Spoon	205mm
服务更	Serving Spoon	273mm
服务漏更	Serving PCB Spoon	273mm



LV2216

18/10 Stainless Steel
5.0mm

	Desc.	Size
正餐刀	Table knife	231mm
正餐叉	Table Fork	222mm
正餐更	Table Spoon	222mm
汤更	Soup Spoon	203mm
茶叉	Tea Fork	143mm
茶更	Tea Spoon	138mm
甜品更	Dessert Spoon	192mm
甜品叉	Dessert Fork	194mm
黄油刀	Butter Knife	148mm
水果叉	Fruit Fork	140mm

LV2210M

18/10 Stainless Steel
5.0mm



LV2216G

18/10 Stainless Steel
5.0mm

	Desc.	Size
正餐刀	Table knife	231mm
正餐叉	Table Fork	222mm
正餐更	Table Spoon	222mm
汤更	Soup Spoon	203mm
茶叉	Tea Fork	143mm
茶更	Tea Spoon	138mm
甜品更	Dessert Spoon	192mm
甜品叉	Dessert Fork	194mm
黄油刀	Butter Knife	148mm
水果叉	Fruit Fork	140mm





LV2208

18/10 Stainless Steel
5.0mm

	Desc.	Size
正餐刀	Table knife	230mm
正餐叉	Table Fork	214mm
正餐更	Table Spoon	210mm
茶更	Tea Spoon	125mm
水果叉	Fruit Fork	133mm

	Desc.	Size
肉叉	Meat Fork	215mm
甜品刀	Dessert Knife	200mm
甜品叉	Dessert Fork	190mm
甜品更	Dessert Spoon	185mm
冰更	Ice tea Spoon	205mm
汤更	Soup Spoon	157mm



LV2217

18/10 Stainless Steel
5.0mm

LV2217G

18/10 Stainless Steel
5.0mm

	Desc.	Size
正餐刀	Table Knife	222mm
正餐叉	Table Fork	210mm
正餐更	Table Spoon	213mm
圆汤更	R.Soup Spoon	205mm
甜品更	Dessert Spoon	165mm
茶更	Tea Spoon	158mm
茶叉	Tea Fork	163mm





LV2203

18/10 Stainless Steel
5.0mm

	Desc.	Size
正餐刀	Table knife	227mm
正餐叉	Table fork	215mm
正餐更	Table spoon	215mm
茶更	Tea spoon	154mm
甜品刀	Dessert Knife	212mm
甜品叉	Dessert Fork	180mm
甜品更	Dessert Spoon	180mm
牛排刀	Steak Knife	227mm
汤更	Soup Spoon	205mm
蛋糕叉	Cake Fork	154mm
水果叉	Fruit fork	151mm
咖啡更	Coffee Spoon	116mm

LV2203BG

18/10 Stainless Steel
5.0mm



LV2203G

18/10 Stainless Steel
5.0mm



LV2021J

18/10 Stainless Steel
4.0mm

	Desc.	Size		Desc.	Size
正餐刀	Table Knife	235mm	咖啡更	Coffee Spoon	108mm
正餐叉	Table Fork	204mm	蛋糕叉	Cake Fork	155mm
正餐更	Table Spoon	204mm	水果叉	Fruit Fork	145mm
甜品刀	Dessert Knife	210mm	黄油刀	Butter Knife	168mm
甜品叉	Dessert Fork	184mm	鱼刀	Fish Knife	208mm
甜品更	Dessert Spoon	183mm	鱼叉	Fish Fork	186mm
牛排刀	Steak Knife	235mm	冰更	Ice Tea Spoon	195mm
汤更	Soup Spoon	176mm	服务叉	Serving Fork	232mm
茶更	Tea Spoon	144mm	服务更	Serving Spoon	232mm

LV2022C

18/10 Stainless Steel
3.5mm



	Desc.	Size
正餐刀	Table Knife	235mm
正餐叉	Table Fork	209mm
正餐更	Table Spoon	208mm
甜品刀	Dessert Knife	210mm
甜品叉	Dessert Fork	192mm
甜品更	Dessert Spoon	190mm
牛排刀	Steak Knife	235mm
汤更	Soup Spoon	190mm
水果叉	Fruit Fork	150mm

	Desc.	Size
茶更	Tea Spoon	150mm
咖啡更	Coffee Spoon	115mm
蛋糕叉*	Cake Fork*	150mm
黄油刀*	Butter Knife*	165mm
冰更*	Ice Tea Spoon*	205mm
鱼刀*	Fish Knife*	190mm
鱼叉*	Fish Fork*	188mm
服务更*	Serving Spoon*	238mm
服务叉*	Serving Fork*	240mm

LV2022R

18/10 Stainless Steel
3.5mm



备注：镀金产品有少量库存，量多时按单生产，货期1周。

LV2022G

18/10 Stainless Steel
3.5mm

	Desc.	Size
正餐刀	Table Knife	235mm
正餐叉	Table Fork	209mm
正餐更	Table Spoon	208mm
甜品刀	Dessert Knife	210mm
甜品叉	Dessert Fork	192mm
甜品更	Dessert Spoon	190mm
牛排刀	Steak Knife	235mm
汤更	Soup Spoon	190mm
水果叉	Fruit Fork	150mm
茶更	Tea Spoon	150mm
咖啡更	Coffee Spoon	115mm
蛋糕叉*	Cake Fork*	150mm
黄油刀*	Butter Knife*	165mm
冰更*	Ice Tea Spoon*	205mm
鱼刀*	Fish Knife*	190mm
鱼叉*	Fish Fork*	188mm
服务更*	Serving Spoon*	238mm
服务叉*	Serving Fork*	240mm

*表示没库存 (NO Stock)

备注：镀金产品有少量库存，量多时按单生产，货期1周。



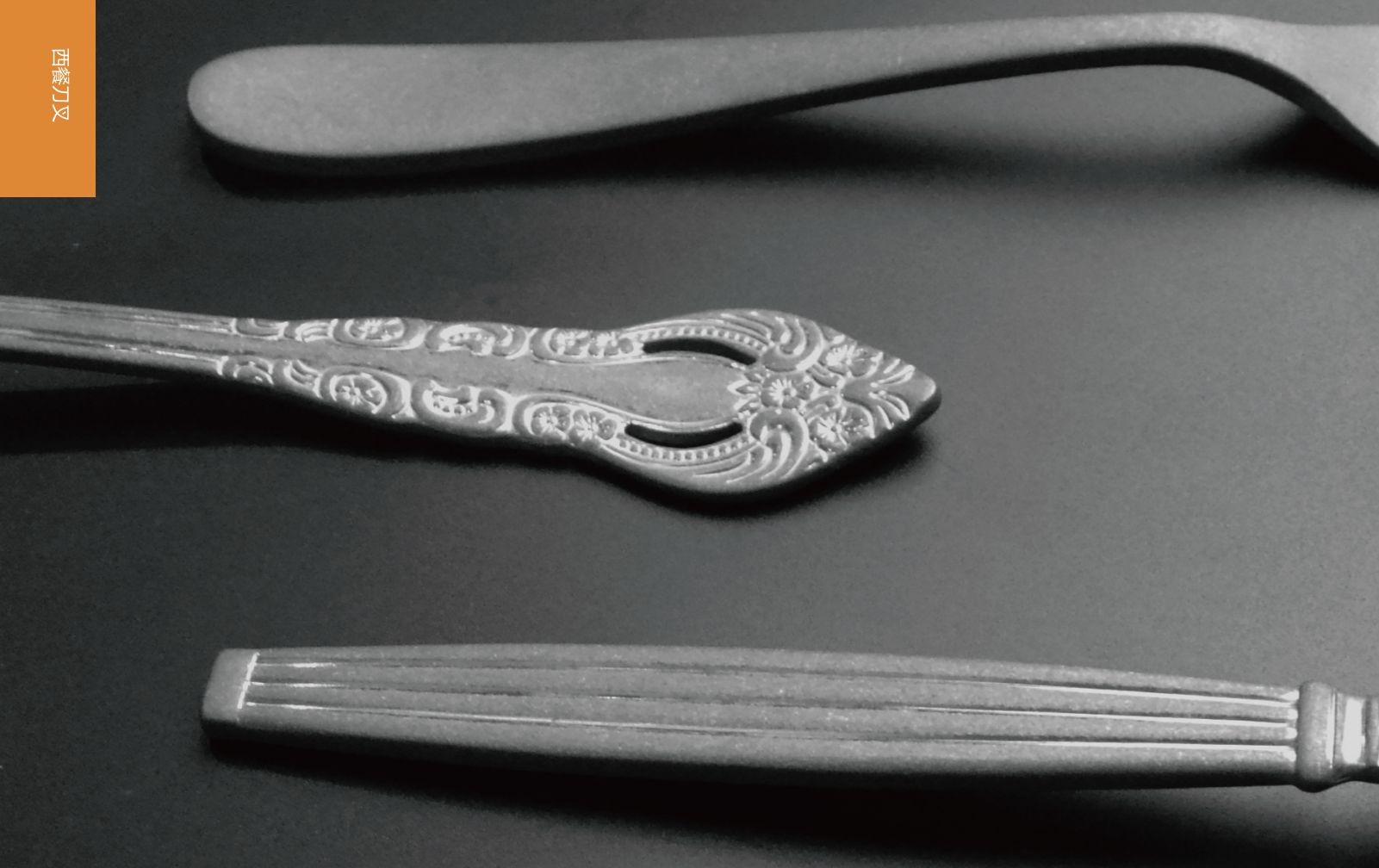

轻复古

轻复古，传达了朴素美学的概念，
希望能将生活的细节与品味融为一体
将审美艺术融入物品中，展现真实的生活状态，
Flocarol更加注重轻复古的使用设计。

每一件都是手工制作和打磨。
经过十多个复杂的过程，
展示自然、精致的产品，
呈现古典美

LV2026J

18/10 Stainless Steel
4mm

	Desc.	Size
正餐刀	Table Knife	235mm
正餐叉	Table Fork	201mm
正餐更	Table Spoon	198mm
甜品叉	Dessert Fork	176mm



CN118J

18/10 Stainless Steel
5.0mm

	Desc.	Size
主餐刀	Table Knife	243mm
主餐叉	Table Fork	202mm
主餐勺	Table Spoon	204mm
甜品叉	Dessert Fork	188mm

LV2012J

18/10 Stainless Steel
5.0mm

	Desc.	Size		Desc.	Size
正餐刀	Table Knife	245mm	咖啡更	Coffee Spoon	115mm
正餐叉	Table Fork	212mm	黄油刀	Butter Knife	183mm
正餐更	Table Spoon	214mm	蛋糕叉	Cake Fork	147mm
甜品刀	Dessert Knife	218mm	水果叉	Fruit Fork	147mm
甜品叉	Dessert Fork	193mm	服务更	Serving Spoon	260mm
甜品更	Dessert Spoon	193mm	漏餐更	PCB Spoon	257mm
牛排刀	Steak Knife	245mm	鱼刀	Fish Knife	181mm
汤更	Soup Spoon	184mm	鱼叉	Fish Fork	183mm
茶更	Tea Spoon	147mm			



LV2003J

18/10 Stainless Steel
4mm

	Desc.	Size		Desc.	Size
正餐刀	Table Knife	244mm	茶更	Tea Spoon	142mm
正餐叉	Table Fork	211mm	咖啡更	Coffee Spoon	114mm
正餐更	Table Spoon	211mm	蛋糕叉	Cake Fork	158mm
甜品刀	Dessert Knife	224mm	黄油刀	Butter Knife	208mm
甜品叉	Dessert Fork	190mm	鱼叉	Fish Fork	190mm
甜品更	Dessert Spoon	190mm	鱼刀	Fish Knife	204mm
汤更	Soup Spoon	179mm			



Desc.

Size

正餐刀	Table Knife	230mm
正餐更	Table Spoon	197mm
正餐叉	Table Fork	200mm
茶更	Tea Spoon	158mm



LV5001

18/10 Stainless Steel
5.0mm

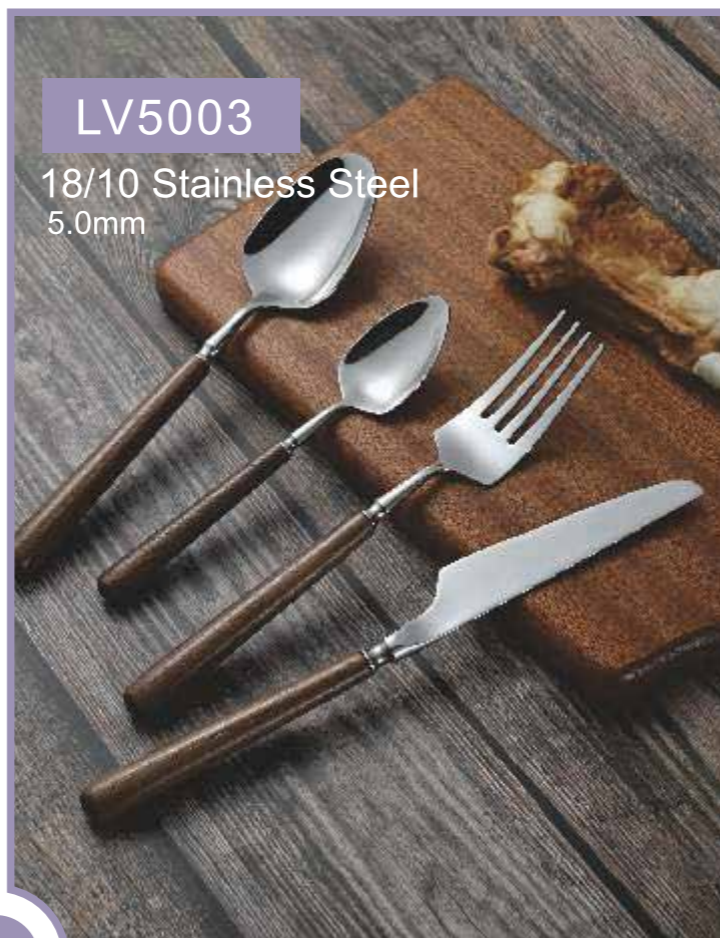

LV5003

18/10 Stainless Steel
5.0mm

LV5002

18/10 Stainless Steel
5.0mm

Desc.

Size

正餐刀	Table Knife	220mm
正餐更	Table Spoon	184mm
正餐叉	Table Fork	192mm
甜品更	Dessert Fork	160mm
甜品叉	Dessert Spoon	174mm



CD1102

Stainless Steel
5.0mm

Desc.

Size

正餐刀	Table Knife	222mm
正餐叉	Table Fork	210mm
正餐更	Table Spoon	207mm
茶叉	Tea Fork	163mm
茶更	Tea Spoon	158mm



CD1101

Stainless Steel
5.0mm

Desc.

Size

正餐刀	Table Knife	200mm
正餐叉	Table Fork	212mm
正餐更	Table Spoon	203mm
茶叉	Tea Fork	145mm
茶更	Tea Spoon	143mm



CM24BJ

24件套礼盒(黑)
24pcs Cutlery Set(Black)



CM24KJ

24件套礼盒(红)
24pcs Cutlery Set(Red)



CM48RB

48件套礼盒套装
48pcs Cutlery Set(black)



CB04R

4格餐具便携展示袋
4 Holes Portable Display Bag For Tableware



CB09R

9格餐具便携展示袋
9 Holes Portable Display Bag For Tableware

CB016R

16格餐具便携展示袋
16 Holes Portable Display Bag For Tableware

CB04R

CB09R

CB016R



ZJ05B

五层展示架
50cm*183cm (带脚垫支撑)
Five layer cutlery display rack
50cm*183cm

ZJ05B-1

五层展示架
50cm*183cm (带轮)
Five layer cutlery display rack (With wheels)
50cm*183cm

ZJ10B

五层展示架
100cm*183cm (带脚垫支撑)
Five layer cutlery display rack
100cm*183cm



LV6002

方形空心筷
18/10 Square S/S Chopsticks
尺寸(Size) 230mm

LV6002M

镀玫瑰金方形空心筷
18/10 Square S/S Chopsticks
尺寸(Size) 230mm

LV6002B

镀黑方形空心筷
18/10 Square S/S Chopsticks
尺寸(Size) 230mm

LV6002L

镀蓝方形空心筷
18/10 Square S/S Chopsticks
尺寸(Size) 230mm

LV6002G

镀钛金方形空心筷
18/10 Square S/S Chopsticks
尺寸(Size) 230mm

LV6002R

镀香槟金方形空心筷
18/10 Square S/S Chopsticks
尺寸(Size) 230mm

*按单定制，货期1周，起订量200双



上面方，下面圆，光滑防滑



容易清洁



耐高温



食品级不锈钢



LV6008

圆形空心筷
Stainless Steel Chopsticks
尺寸(Size) 230mm

LG

LV6008LG

BG

LV6008BG

WG

LV6008WG

CG

LV6008CG

不锈钢吸管

LV6009-1

直形 Straight
尺寸(Size) 21.5mm

LV6009-2

弯曲 Bending
尺寸(Size) 20.5mm

18/10 Stainless Steel

LV6009-1

LV6009-2





FC-060

FC-060CF	锤纹蛋糕叉 Hammer shaped cake fork	13.2cm
FC-060IF	锤纹水果叉 Hammer shaped fruit fork	9.3cm
FC-060CS	锤纹咖啡更 Hammer patterned coffee	12.5cm
FC-060PS	锤纹雪糕更 Hammer shaped ice cream	12.5cm

FC-060G

FC-060(G)CF	镀金锤纹蛋糕叉 Gold plated hammer patterned cake fork	13.2cm
FC-060(G)IF	镀金锤纹水果叉 Gold plated hammer patterned fruit fork	9.3cm
FC-060(G)CS	镀金锤纹咖啡更 Gold plated hammer patterned coffee	12.5cm
FC-060(G)PS	镀金锤纹雪糕更 Gold Plated Hammer Pattern Ice Cream	12.5cm



FC-005

FC-005SS	龙更 Dragon spoon	20.5cm
FC-005TF	龙叉 Dragon fork	21cm

FC-005G

FC-005(G)SS	镀金龙更 Gold-plated Dragon spoon	20.5cm
FC-005(G)TF	镀金龙叉 Gold Plated Dragon fork	21cm



FC-061

FC-061S	树叶勺 Leaf spoon	12.5cm
FC-061F	树叶叉 Leaf fork	12.5cm

FC-061G

FC-061GS	镀金树叶勺 Gold-plated Leaf Spoon	12.5cm
FC-061GF	镀金树叶叉 Gold Plated Leaf Fork	12.5cm



FC-016

FC-016JS	工铲型甜品勺 Shovel shaped dessert spoon	15.5cm
FC-016YF	工铲型甜点叉 Shovel shaped dessert fork	15.5cm
FC-016PS	工铲型方勺 Shovel type square spoon	15.5cm

FC-016G

FC-016(G)JS	镀金工铲型甜品勺 Gold plated shovel type dessert spoon	15.5cm
FC-016(G)YF	镀金工铲型甜点叉 Gold plated shovel type dessert fork	15.5cm
FC-016(G)PS	镀金工铲型方勺 Gold-plated shovel type square spoon	15.5cm



FC-073

FC-073	方头马克杯勺 (小号) Square headed mug spoon (small)	15cm
FC-073-1	方头马克杯勺 (中号) Square headed mug spoon (medium)	17cm

FC-073G

FC-073G	镀金方头马克杯勺 (小号) Gold Plated Square Head Mug Spoon (Small)	15cm
FC-073G-1	镀金方头马克杯勺 (中号) Gold Plated Square Head Mug Spoon (Medium)	17cm



咖啡更

咖啡更 Coffee Spoon	编号(Code)	尺寸(Size)
	FC-006CS	15.5cm



咖啡更

咖啡更 Coffee Spoon	编号(Code)	品名 (Desc.)	尺寸(Size)
	FC-013CS	勺(Spoon)	134mm
	FC-013IF	叉(Fork)	137mm



甜点叉勺

甜点叉勺 Pastry Flatware Set	编号(Code)	品名 (Desc.)	尺寸(Size)
	LV2201ES	勺(Spoon)	125mm
	LV2201CF	叉(Fork)	125mm



牛排刀叉

牛排刀叉 Steak Fork And Knife	编号 (Code)	品名 (Desc.)
	FC-010SK	刀(Knife)
	FC-010SF	叉(Fork)



蛋糕铲

蛋糕铲 Buffet serving spoon	编号(Code)	尺寸(Size)
	A LV006CR	250mmX53mm
	B MC022CFH	255mmX48mm
	C MC022-C-CFH	255mmX48mm



双头咖啡勺

双头咖啡勺 Double Head Spoon	编号(Code)	尺寸(Size)
	FC-007MS	19.5cm



甜品叉勺

甜品叉勺 Pastry Flatware	编号(Code)	品名 (Desc.)	尺寸(Size)
	FC-022ES	勺(Spoon)	135mm
	FC-022CF	叉(Fork)	135mm



甜点叉勺

甜点叉勺 Pastry Flatware Set	编号(Code)	品名 (Desc.)	尺寸(Size)
	LV2202BA-ES	勺(Spoon)	144mm
	LV2202BA-CF	叉(Fork)	147mm



汤匙

汤匙 Soup Spoon	编号(Code)	尺寸(Size)
	FC-013SS(S)	13.3cmX3.5cm
	FC-013SS(M)	14.5cmX4.0cm
	FC-013SS(L)	16.2cmX4.3cm



酒吧长柄匙

酒吧长柄匙 Bar Spoon	编号(Code)	尺寸(Size)
	FC-015BS	260mm
	FC-015BF	261mm



弯柄勺

弯柄勺 Coffee Spoon	编号(Code)	尺寸(Size)
	FC-005CS	98mm
	FC-005ES	126mm
	FC-005-1CS	147mm
	FC-005-2CS	150mm



甜点叉勺

甜点叉勺 Pastry Flatware	编号(Code)	品名 (Desc.)	尺寸(Size)
	LV9005ES	勺(Spoon)	135mm
	LV9005CF	叉(Fork)	136mm



甜点叉勺

甜点叉勺 Pastry Flatware	编号(Code)	品名 (Desc.)	尺寸(Size)
	MC022-C-ES	勺(Spoon)	148mm
	MC022-C-CF	叉(Fork)	147mm



弯柄勺

弯柄勺 Happy Flatware	编号(Code)	尺寸(Size)
	FC-012DS	122mm
	FC-012DF	122mm
	FC-012SS	120mm



304锤纹分菜勺/漏勺

304锤纹分菜勺/漏勺 Service Spoon With Holes(small And Big)	编号(Code)	尺寸(Size)
	C91201-1	29*7
	C91201-2	33.5*7.2
	C91201L-1	29*7
	C91201L-2	33.5*7.2



沙拉/服务 套装

Salad/buffet Serving Set

编号(Code) 品名 (Desc.) 尺寸(Size)
LV1010RS 勺(Spoon) 19.8cmX7cm
LV1010RF 叉(Fork) 19.8cmX7cm



沙拉/服务 套装

Salad/buffet Serving Set

编号(Code) 品名 (Desc.) 尺寸(Size)
LV2006RS 勺(Spoon) 25cm
LV2006RF 叉(Fork) 25cm



沙拉/服务 套装

Salad/buffet Serving Set

编号(Code) 品名 (Desc.) 尺寸(Size)
CN118RS 勺(Spoon) 220mm
CN118RF 叉(Fork) 220mm

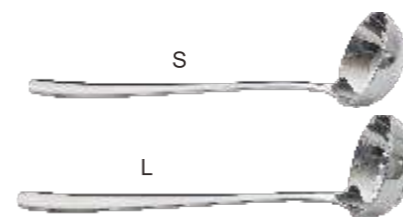

304汤勺/漏勺

Colander Ladle And Soup Ladle

编号(Code) 尺寸(Size)
C90152-6L 19.5cm
C90152-6S 19.5cm
C90152-7L 29cm
C90152-7S 29cm



锤纹火锅漏/勺

Hammer pattern hot pot leak/spoon

编号(Code) 尺寸(Size)
C90151-6L 19cm
C90151-6S 19cm
C90151-7L 28cm
C90151-7S 28cm



304汤勺/漏勺

Colander Ladle And Soup Ladle

编号(Code) 尺寸(Size)
C90153-8L 长30cm, 勺头宽8cm
C90153-8S 长30cm, 勺头宽8cm
C90153-7L 长24cm, 勺头宽7cm
C90153-7S 长24cm, 勺头宽7cm



沙拉/服务 套装

Salad/buffet Serving Set

编号(Code) 品名 (Desc.) 尺寸(Size)
LV006RS 勺(Spoon) 24cm
LV006RF 叉(Fork) 24cm



沙拉/服务 套装

Salad/buffet Serving Set

编号(Code) 品名 (Desc.) 尺寸(Size)
MC022-C-RS 勺(Spoon) 21.4cm
MC022-C-RF 叉(Fork) 21.4cm



沙拉/服务 套装

Salad/buffet Serving Set

编号(Code) 品名 (Desc.) 尺寸(Size)
MC022RS 勺(Spoon) 21.4cm
MC022RF 叉(Fork) 21.4cm



沙拉/服务 套装

Salad/buffet Serving Set

编号(Code) 品名 (Desc.) 尺寸(Size)
LV9005RS 勺(Spoon) 24.1cm
LV9005RF 叉(Fork) 24.7cm

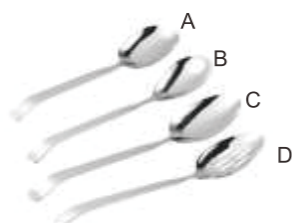

沙拉/服务 勺

Salad/buffet Serving Set

编号(Code) 尺寸(Size)
C91200A 27.5cmX9cm
C91200B 27.5cmX9cm
C91200C 27.8cmX9cm
C91200D 27.5cmX9cm



沙拉/服务 勺

Salad/buffet Serving Set

编号(Code) 尺寸(Size)
C90126 245mm
C90127 245mm
C90128A 270mm
C90128B 335mm
C90129 335mm



不锈钢分菜勺

Stainless steel spoon

编号(Code) 尺寸(Size)
C90142S 29.6CM
C90142L 29.6CM
C90143S 35.5CM
C90143L 35.5CM



不锈钢分菜勺

Stainless steel spoon

编号(Code) 尺寸(Size)
C90144S 28CM
C90144L 28CM
C90144F 28CM



服务更

Service improvement

编号(Code) 尺寸(Size)
C90148-1 29cmX7cm
C90148-2 25cmX7cm
C90148-3 24.5cmX6cm
C90148-4 20.5cmX6cm



汤勺/汁勺

Soup Ladle

编号(Code) 尺寸(Size)
MC022SL 280mm
MC022GL 185mm



汤勺/汁勺

Soup Ladle

编号(Code) 尺寸(Size)
LV006SL 320mm
LV006GL 230mm



汤勺/汁勺

Soup Ladle

编号(Code) 尺寸(Size)
CN118SL 320mm
CN118GL 180mm



304款火锅勺

Hot Pot Tools

编号(Code) 尺寸(Size)
C90140-S 27.5cmX7.3cm
C90140-L 27.5cmX7.3cm



304如意火锅漏/勺

Ruyi Hot Pot Leakage/Spoon

编号(Code) 尺寸(Size)
C90146-6S 6分, 27cm
C90146-6L 6分, 27cm
C90146-7S 7分, 30cm
C90146-7L 7分, 30cm



汤勺/汁勺

Soup Ladle

编号(Code) 尺寸(Size)
MC022-C-SL 280mm
MC022-C-GL 185mm



火锅勺

Hot Pot Tools

编号(Code) 尺寸(Size) 编号(Code) 尺寸(Size)
C90113-6S 19cmX6cm C90113-7L 22cmX7cm
C90113-6L 19cmX6cm C90113-8S 25cmX8cm
C90113-7S 22cmX7cm C90113-8L 25cmX8cm



火锅勺

Hot Pot Tools

编号(Code) 尺寸(Size)
C90103-6S 19cmX6cm
C90103-6L 22cmX6cm
C90103-7S 22cmX6cm
C90103-7L 28cmX7m



火锅勺

Hot Pot Tools

编号(Code) 尺寸(Size)
C90104-7S 25cmX7cm
C90104-7L 25cmX7cm



火锅勺 Hot Pot Tools

编号(Code)	尺寸(Size)
C90109-6S	21cmX6cm
C90109-6L	21cmX6cm
C90109-7S	28cmX7cm
C90109-7L	28cmX7cm

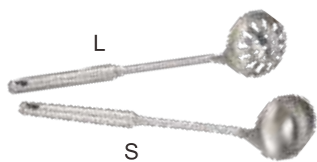

304 空心柄火锅漏/勺 Hollow Handle Hot Pot Drain/spoon

编号(Code)	尺寸(Size)
C90141-7S	7cm*28.3cm
C90141-7L	7cm*28.3cm
C90141-8S	8cm*30cm
C90141-8L	8cm*30cm

厨师工具 chef's tools



36.5cm C90137MF 35cm C90137TA 35cm C90137PS 37cm C90137PM 28cm C90137SM 34cm C90137PB 38cm C90137PA 35cm C90137LA

厨师工具 chef's tools

编号(Code)	尺寸(Size)	编号(Code)	尺寸(Size)
C90138-1	3.5x23cm	C90138-9	8x26.5cm
C90138-2	4.1x23cm	C90138-10	9.5x28cm
C90138-3	4.9x23cm	C90138-11	10.5x29cm
C90138-4	5.4x23cm	C90138-12	11.5x30cm
C90138-5	5.8x23cm	C90138-13	13x30cm
C90138-6	6.5x26cm		
C90138-7	7x26cm		
C90138-8	7.4x25.5cm		



汁勺碟架 Spoon Stand

编号(Code)	尺寸(Size)
C1506	270mmx115mmx30mm



不锈钢方柄火锅漏/勺 Square handle hot pot drain/spoon

编号(Code)	尺寸(Size)
C90150-5S	5cm*21.5cm
C90150-5L	5cm*21.5cm
C90150-6S	6cm*22cm
C90150-6L	6cm*22cm
C90150-7S	7cm*29cm
C90150-7L	7cm*29cm
C90150-8S	8cm*31cm
C90150-8L	8cm*31cm



高档方柄单头汤壳架配碗 (哑黑) Single Soup Spot Stand

编号(Code)	尺寸(Size)
C1521B-1	22.3*10 碗口径9.5

高档方柄双头汤壳架配碗 (哑黑) Double Soup Spot Stand

编号(Code)	尺寸(Size)
C1521B-2	22.3*17.6 碗口径9.5



汤匙架 Soup Spoon Stand

编号(Code)	尺寸(Size)	编号(Code)	尺寸(Size)
C1501	9.5cmX17.5cm	C1503	10cmX21cm
C1502	10cmX18cm	C1504	10cmX21cm

全钢汤匙架 Soup Spoon Stand

编号(Code)	尺寸(Size)
C1505	12cmX18cm



盖匙架 Lid And Spoon Rest

编号(Code)	尺寸(Size)
C1507	18.5X15.5X19.5cm



防烫剪式漏夹 Anti scalding and shearing type leakage clamp

编号(Code)	尺寸(Size)
C1070	26.8CM



叉剪餐夹304 Fork cut meal clip 304

编号(Code)	尺寸(Size)
C1062	26.7CM



尖铲餐夹304 Sharp shovel meal clip 304

编号(Code)	尺寸(Size)
C1064	29CM



剪式304沙律夹 Scissor style 304 salad clip

编号(Code)	尺寸(Size)
C1069-2	24.5CM



漏剪餐夹304 Missing cut meal clip 304

编号(Code)	尺寸(Size)
C1061	19.8CM



剪式304方头漏夹 Scissor type 304 square head clamp

编号(Code)	尺寸(Size)
C1069-1	24.5CM



沙拉/自助服务夹 Salad/buffet Serving Tongs

编号(Code)	尺寸(Size)
C1039A	1.5mm 22.8cm



沙拉/自助服务夹 Salad/buffet Serving Tongs

编号(Code)	尺寸(Size)
C1039B	1.5mm 22.8cm



沙拉/自助服务夹 Salad/buffet Serving Tongs

编号(Code)	尺寸(Size)
C1039C	22.5cm



双密餐夹304 Double density meal clip 304

编号(Code)	尺寸(Size)
C1065	23cm



沙拉/自助服务夹 Salad/buffet Serving Tongs

编号(Code)	尺寸(Size)
C1041	12"



沙拉/自助服务夹 Salad/buffet Serving Tongs

编号(Code)	尺寸(Size)
C1042	11.5"



沙拉/自助服务夹
Salad/buffet Serving Tongs
编号(Code) 尺寸(Size)
C1027-9 9"
C1027-12 12"



面包夹
Bread Tongs
编号(Code) 尺寸(Size)
C1043-9 24cm
C1043-11 28cm



沙拉/自助服务夹
Salad/buffet Serving Tongs
编号(Code) 尺寸(Size)
C1044 10"



304 冰夹/毛巾夹
Ice clip/towel clip
编号(Code) 尺寸(Size)
C1058 185mm



食品夹
Food Tongs
编号(Code) 尺寸(Size)
C1037-9 9"
C1037-12 12"
C1037-16 16"

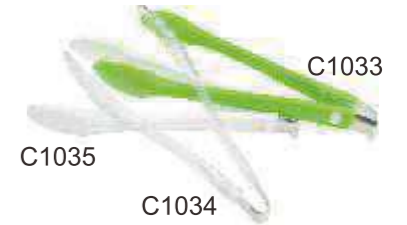

面包夹(透明)
Bread Tongs(transparent)
编号(Code) 尺寸(Size) 编号(Code) 尺寸(Size)
C1033-9 9" C1034-10 10"
C1033-10 10" C1034-11 11"
C1033-11 11" C1035-9 9"
C1034-9 9" C1035-10 10"
C1035-11 11"



牛排夹
Steak Tongs
编号(Code) 尺寸(Size)
C1028 26cm



沙拉/自助服务夹
Salad/buffet Serving Tongs
编号(Code) 尺寸(Size)
C1026-8 8"
C1026-10 10"
C1026-12 12"



带锁的牛排夹
Steak Tongs With Lock
编号(Code) 尺寸(Size)
C1045-9 9"
C1045-12 12"



面包夹
Bread Tongs
编号(Code) 尺寸(Size) 编号(Code) 尺寸(Size)
C1016A 9" C1016D 9"
C1016B 9" C1016E 9"
C1016C 9" C1016F 9"



糕点夹
Pastry Tongs
编号(Code) 尺寸(Size)
C1013 18cmx7.5cmx3.5cm



肉球夹
Ball Food Tongs
编号(Code) 尺寸(Size)
C1021A φ34×160mm
C1021B φ40×165mm
C1021C φ44×170mm
C1021D φ50×175mm



面包夹
Bread Tongs
编号(Code) 尺寸(Size)
C1047 240mm



龙虾夹
Lobster Tongs
编号(Code) 尺寸(Size) 编号(Code) 尺寸(Size)
C1032-6 6" C1032-8 8"
C1032-7 7" C1032-9 9"
C1032-10 10"



食品夹
Food Tongs
编号(Code) 尺寸(Size) 编号(Code) 尺寸(Size)
C1031-4 4" C1031-9 9"
C1031-6 6" C1031-10 10"
C1031-7 7" C1031-12 12"



冰淇淋勺
Ice Cream Spoon
编号(Code) 尺寸(Size)
C1049A 18cm
C1049B 18cm



冰淇淋勺
Ice Cream Spoon
编号(Code) 尺寸(Size)
C1048-1 φ4.5cm
C1048-2 φ5cm
C1048-3 φ6cm



鸡蛋夹
Egg Tongs
编号(Code) 尺寸(Size)
C1046 18.2cmx6cmx4cm



沙拉/自助服务夹
Salad/buffet Serving Tongs
编号(Code) 尺寸(Size)
C1005A 9"
C1005B 9"
C1005C 9"



沙拉/自助服务夹
Salad/buffet Serving Tongs
编号(Code) 尺寸(Size)
C1004A 9"
C1004B 9"
C1004C 9"



带孔食物夹
Food Tongs With Hole
编号(Code) 尺寸(Size)
C1002-9 9"
C1002-7 7"
C1002-5 5"



糕点夹
Pastry Tongs
编号(Code) 尺寸(Size)
C1012B 8"



冰夹
Ice Tongs
编号(Code) 尺寸(Size)
C1003-6 6"
C1003-7 7"
C1003-8 8"



冰夹
Ice Tongs
编号 尺寸(Size)
C1052-6 6"
C1052-7 7"
C1052-8 8"
C1052-9 9"



冰夹
Ice Tongs
编号(Code) 尺寸(Size)
C1053-6 6"
C1053-7 7"
C1053-8 8"
C1053-9 9"



冰夹
Ice Tongs
编号(Code) 尺寸(Size)
C1054 18.2cmx6cmx4cm



糖夹
Sugar Tongs
编号(Code) 尺寸(Size)
C1009 10.8cm



开罐器
Bottle Opener
编号(Code)
FC-065F



果勺
Melon Baller
编号(Code)
FC-065B



开罐器
Opener
编号(Code)
FC-065D



糖夹
Sugar Tongs
编号(Code) 尺寸(Size)
C1010 10cm



台布夹
Tablecloth Tongs
编号(Code) 尺寸(Size)
C1057 6.5CMX4.5CMX2.0CM



蜗牛夹
Snail Tweezer
编号(Code) 尺寸(Size)
C1038 15.5cm



压蒜器
Garlic press
编号(Code) 尺寸(Size)
FC-065L 19cmX2.3cm



半自动打蛋器
S/S Whisk
编号(Code) 尺寸(Size)
C26007 30.5CMX6.5CMX6.5CM



油刷
S/S Oil Brush
编号(Code) 尺寸(Size)
C26008-1 19.8cm
C26008-2 30.5cm



蟹肉夹
crab tongs
编号(Code) 尺寸(Size)
C1056 20cm



鱼骨夹
Hair clips
编号(Code) 尺寸(Size)
C1055 12cm



削皮器
Vegetable Peeler
编号(Code) 尺寸(Size)
C26003 11.3cm



不锈钢芝士铲
Stainless Steel Cheese Scoop
编号(Code) 尺寸(Size)
FC-067CL 22.5cm



芝士刀 (四孔)
Cheese Knife
编号(Code) 尺寸(Size)
FC-067CK 23.3cm



黄油刀
Butter Knife
编号(Code) 尺寸(Size)
FC-067BK 21.5cm



304不锈钢煎蛋圈
Egg Rings Non Stick
编号(Code) 尺寸(Size)
C26009-1 7.5CM
C26009-2 9.0CM



切蛋器
Egg Slicer
编号(Code) 尺寸(Size)
C26010W(白) 8.8*12.4CM



切蛋器
Egg Slicer
编号(Code) 尺寸(Size)
C26010B(黑) 8.8*12.4CM



胶柄防滑披萨刀/铲
Rubber Handle Pizza Knife And Shovel
编号(Code) 尺寸(Size)
LS90023-1 10.2*23.6cm
LS90023-2 26.6CM



披萨刀
Pizza Catter
编号(Code) 尺寸(Size)
FC-065I ϕ 73x220mm



冰激凌勺
Ice Cream Scoop
编号(Code)
FC-065E



开罐器
Can opener
编号(Code)
FC-065K



红酒开瓶器
Red wine opening
编号(Code) 尺寸(Size)
LS24225 20cm*7cm 35.0



广口开罐器
Jar Opener
编号(Code)
FC-065M



削皮刀
Vegetable PeeLER
编号(Code)
FC-065A



去芯器
Core Remover Tool
编号(Code) 尺寸(Size)
FC-065G 20cmX2cm



奶酪刀
Cheese Knife
编号(Code) 尺寸(Size)
FC-065H 23cmX2cm

厨房工具

不锈钢/钛合金制造

专业厨房工具



量匙
Measuring Spoons
编号(Code) 尺寸(Size)
C26014



不锈钢片柄量匙
Measuring Spoons
编号(Code) 尺寸(Size)
C26012 Stp 1/4
Stp 1/2
Tsp 1
Tbsp 1/2
Tbsp 1
Tbsp 1 1/2



不锈钢线柄量匙
Measuring Spoons
编号(Code) 尺寸(Size)
C26013 1/4 Tsp
1/2tsp
1 Tsp
1 Tbsp



量匙
Measuring Spoons
编号(Code) 尺寸(Size)
C26015 1 tbsp = 15ml
1 tsp = 5ml
1/2 tsp = 2.5ml
1/4 tsp = 1.25ml
1/8 tsp = 0.6ml



5件套方柄量匙 (A款) 镜光
Measuring Spoons
编号 (Code) 尺寸(Size)
C26016 15ml 1
7.5ml 1/2
5ml 1
2.5ml 1/2
TABLESPOON 1/4



4件套量匙 (INOX标记)
Measuring Spoons
编号(Code) 尺寸(Size)
C26017 15ml
5ml
2.5ml 1/2
1.25ml 1/4



全不锈钢海鲜钳
lobster-crack
编号(Code) 尺寸(Size)
C25036 17.5cmX3.5cm



全钢蟹钳
Crab tools
编号(Code) 尺寸(Size)
C25016 16cmX3.5cm



塑料柄蟹钳
Crab tools
编号(Code) 尺寸(Size)
C25014 16cmX4cm



浸胶蟹钳
Crab tools
编号(Code) 尺寸
C25021 16.5cmX3.5cm



全钢蟹钳
Crab tools
编号(Code) 尺寸(Size)
C25024 16cmX35cm



合金蟹钳
Crab tools
编号(Code) 尺寸(Size)
C25038 17cmX3.5cm

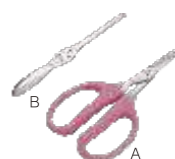

蟹具两件套
Seafood Tools Set
编号(Code) 尺寸(Size)
C25017A 17cmX8cm
C25017B 15.5cmX1.5cm

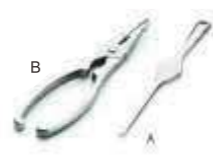

蟹具两件套
Seafood Tools Set
编号(Code) 尺寸(Size)
C25013A 17.5cmX1.5cm
C25013B 18cmX4cm



蟹针
Seafood Fork
编号(Code) 尺寸(Size)
C25040
C25039



蟹具八件套 (锦盒)
Crab set of eight pieces (brocade box)
编号(Code)
C25043



不锈钢蟹钳套装
Stainless steel crab claw set
编号(Code) 尺寸(Size)
C25013 17.5X1.5/18X4cm



蟹钳
Crab forceps
编号(Code) 尺寸(Size)
C25026 17.2cm



彩柄小型鸡骨剪
Kitchen Scissors
编号(Code)
C25034



全钢不锈钢鸡骨剪
Kitchen Scissors
编号(Code)
C25035



4件套量杯
Measuring Spoons
编号(Code) 尺寸(Size)
C26018 60ml cup1/4
80ml cup1/3
125ml cup1/2
250ml cup1



不锈钢七个装量杯
Measuring Spoons
编号(Code) 尺寸(Size)
C26019 2 Tablespoon 30ml
1 1/2tablespoon 22.5ml
1 Tablespoon 15ml
2 Teaspoon 10ml
1 Teaspoon 5ml
1/2 Tablespoon 2.5ml
1/4 Tablespoon 1.25ml
1/8 Tablespoon 0.625ml



不锈钢胶柄量匙
Measuring Spoons
编号(Code) 尺寸(Size)
C26020 1tbsp
1 Tsp
1/2 Tsp
1/4 Tsp



分蛋器
Egg Separator
编号(Code) 尺寸(Size)
C26021 17cm



304不锈钢实心肉锤
Meat hammer
编号(Code) 尺寸(Size)
C26022 21cmx5.8cmx5cm



餐铃
kitchen bell
编号(Code) 尺寸(Size)
C26023 10cmx7cm



筷子托
Chopstick Set
编号(Code)
C1305



筷子托
Chopstick Set
编号(Code)
C1304
C1304-G



筷子托
Chopstick Set
编号(Code)
C1306
C1306-G

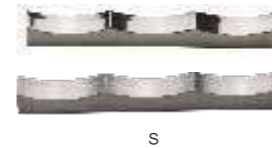

筷子托
Chopstick Set
编号(Code) 尺寸(Size)
C1323 9.2*1.0cm
C1323-S 9.2*1.0cm

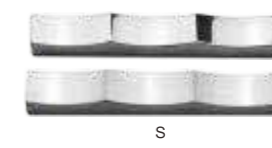

筷子托
Chopstick Set
编号(Code) 尺寸(Size)
C1324 8.7*1.6cm
C1324-S 8.7*1.6cm

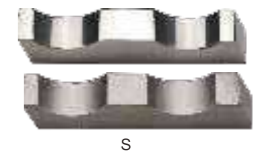

筷子托
Chopstick Set
编号(Code) 尺寸(Size)
C1325 6.9*1.6cm
C1325-S 6.9*1.6cm

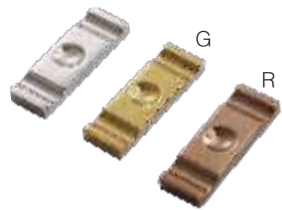

三用筷子架
Chopsticks rack
编号(Code)
C1332
C1332G
C1332R



筷子托
Chopstick Set
编号(Code)
C1308
C1308-G
C1308-M



筷子托
Chopstick Set
编号(Code)
C1303



筷子托
Chopstick Set
编号(Code) 尺寸(Size)
C1326 6.2*1.0cm
C1326-S 6.2*1.0cm

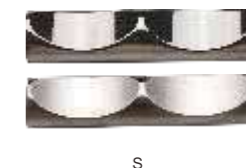

筷子托
Chopstick Set
编号(Code) 尺寸(Size)
C1328 6.2*1.6cm
C1328-S 6.2*1.6cm



筷子托
Chopstick Set
编号(Code) 尺寸(Size)
C1322 9.9*1.6cm
C1322-S 9.9*1.6cm



双T形筷子架
Double T-shaped chopstick set
编号(Code)
C1313-S
C1313-G



T形筷子架
T-shaped chopstick set
编号(Code)
C1312-S
C1312-G



W锤纹筷子架
W-hammer pattern chopstick holder
编号(Code)
C1329
C1329-G
C1329-M



筷子托
Chopstick Set
编号(Code)
C1330
C1330-G
C1330--M



筷子托
Chopstick Set
编号(Code) 尺寸(Size)
C1321 7.9*1.6cm
C1321-S 7.9*1.6cm



筷子托
Chopstick Set
编号(Code) 尺寸(Size)
C1320 8.3*1.6cm
C1320-S 8.3*1.6cm



筷子托
Chopstick Set
编号(Code) 尺寸(Size)
C1329 4.0*1.8cm



筷子托
Chopstick Set
编号(Code) 尺寸(Size)
C1330 4.1*1.5cm



筷子托
Chopstick Set
编号(Code) 尺寸(Size)
C1331 4.3*1.7cm



全金弹弓餐巾圈
Gold Napkin Ring
编号(Code)
LS29310



全银弹弓餐巾圈
Napkin Ring
编号(Code)
LS29311



全银六珠弹弓餐巾圈
Napkin Ring
编号(Code)
LS29312



螺旋叉形全银餐巾圈
Napkin Ring
编号(Code)
LS29313



全银方格通花
Napkin Ring
编号(Code)
LS29314



两头金批花金圈
Napkin Ring
编号(Code)
LS29315



全银玫瑰巾圈
Gold napkin ring
编号(Code) LS29316



全银通花福禄喜
Napkin Ring
编号(Code) LS29318



不锈钢镂空纸巾座
Stainless Steel Hollow Tissue Holder
编号(Code) 尺寸(Size)
C1520 12 × 3.3CM



毛巾碟
Table towel tray
编号(Code) 尺寸(Size)
C1602 15cmX2.5cmX6cm



点心盘
Table Towel Tray
编号(Code) 尺寸(Size)
C1603-1 18.6x9.3mm
C1603-2 23.2X10.3mm
C1603G-1 18.6x9.3mm
C1603G-2 23.2X10.3mm



毛巾碟
Serving Tray
编号(Code) 尺寸(Size)
C1601 2.5mmX 10X14



斜面圆柱实行台座
Card Holder
编号(Code) 尺寸(Size)
LS29012 Φ3XH5.3cm



平面圆柱实心台座
Card Holder
编号(Code) 尺寸(Size)
LS29013 3.6X2.5X2.2cm



半圆实心台座
Card Holder
编号(Code) 尺寸(Size)
LS29015 4X2.5X1.25cm
LS29016 6X3X1.5cm



方形纸巾座
Able Paper Rack
编号(Code) 尺寸(Size)
C1516-1 165x170x110cm
C1516-2 220x190x110cm



钟锤纸巾座金色 (小号)
Clock Hammer Tissue Holder (Gold Small)
编号(Code) 尺寸(Size)
C1517-1G 135 × 138 × 130



钟锤纸巾座
Able Paper Rack
编号(Code) 尺寸(Size)
C1517-1 135x138x130cm
C1517-2 170x170x170cm



月亮形纸巾夹
Table Paper Rack
编号(Code) 尺寸(Size)
C1518 147x30x81cm



月亮形纸巾夹
Table Towel Tray
编号(Code) 尺寸(Size)
C1519 147x30x81cm



牛油碟
Able Paper Rack
编号(Code) 尺寸(Size)
C1604 18.5cmx12.2cmx6.8cm



大长方形实行台座
Card Holder
编号(Code) 尺寸(Size)
LS29017 4x3x2cm



斜面方形实心台座
Card Holder
编号(Code) 尺寸(Size)
LS29025 25x25x34mm
LS29026 25x25x55mm



印章实心台座
Card Holder
编号(Code) 尺寸(Size)
LS29019 Φ3X5cm



球形实心台座
Card Holder
编号(Code) 尺寸(Size)
LS29020 Φ2.8XH2.5cm



2/3圆形实心台座
Card Holder
编号(Code) 尺寸(Size)
LS29021 4X4X3.5cm



小长方形实心台座
Card Holder
编号(Code) 尺寸(Size)
LS29029 4X1X1cm
LS29014 4X2X2cm

台号牌

为您整理出不锈钢台号牌
酒店餐桌牌
饭店菜牌插卡牌
自助餐桌卡架
号码餐牌



方形斜边实心台座
Card Holder

编号(Code) 尺寸(Size)
LS29022 2.5X2.5X2.5cm



方形实心台座
Card Holder

编号(Code) 尺寸(Size)
LS29023 2.5X2.5X2.5cm



三角形台座
Card Holder

编号(Code) 尺寸(Size)
LS29024 7x5.5x7cm



全钢一品红酒架
Wine Rack

编号(Code) 尺寸(Size)
LS24105 150mmx90mmx245mm



L型红酒架
Wine Rack

编号(Code) 尺寸(Size)
LS24121 235mmx100mmx200mm



全钢炮型酒架
Wine Rack

编号(Code) 尺寸(Size)
LS24120 225mmx100mmx100mm



半圆实心台座

Card Holder
编号(Code) 尺寸(Size)
LS29018 80X30cm



大长方形实心台座

Card Holder
编号(Code) 尺寸(Size)
LS29028 100x30mm



月牙弯筷子底座

Chopstick Stand
编号(Code) 尺寸(Size)
LS29027 5.5x1.5cm



X形鹅形餐牌座
Card Holder

编号(Code)	高度 (Size)	卡槽尺寸(Card Size)
LS29008-1	15cm	80mm x 40mm
LS29008-2	20cm	
LS29008-3	25cm	
LS29010-1	16cm	96mm x 56mm
LS29010-2	24cm	



X形台号牌
Card Holder

编号(Code) 尺寸(Size)
LS29116 H16.8cm 11X6.2cm



I形台号牌
Card Holder

编号(Code) 尺寸(Size)
LS29119 9cmXH9.3cm



LS29111 LS29112 LS29113 LS29115

扇形餐牌
Menu Stand

编号(Code)	尺寸(Size)
LS29111	5/6/8/10/11/12/13/14/16/18 "
LS29112	5/6/8/10/11/12/13/14/16/18 "
LS29113	5/6/8/10/11/12/13/14/16/18 "
LS29115	5/6/8/10/11/12/13/14/16/18 "



心形鹅形餐牌座
Card Holder

编号(Code)	高度 (Size)	卡槽尺寸(Card Size)
LS29007-1	15cm	80mm x 40mm
LS29007-2	20cm	
LS29007-3	25cm	
LS29009-1	16cm	96mm x 56mm
LS29009-2	24cm	



不锈钢台号牌
Table Number Stand

编号(Code) 尺寸(Size)
LS29120-1 H280mm
LS29120-2 H380mm
LS29120-3 H480mm



高托莲花实心台座
Table Number Stand

编号(Code) 尺寸(Size)
LS29117 H450mm
LS29118 H380mm



LS29002

禁烟牌
No Smoking Warning Sign

编号(Code) 尺寸(Size)
LS29002 5X4.5cm
LS29003 12X5cm



台号牌 (1-60)
Table Number
编号(Code) 尺寸(Size)
LS29001 5cm



中英文留座牌
Reserved Table Sign
编号(Code) 尺寸(Size)
LS29004 12X5cm



不锈钢功能说明牌
Instruction manual display board
编号(Code) 尺寸(Size)
LS29030 7CM*10CM



大英文留座牌
Reserved Table Sign
编号(Code) 尺寸(Size)
LS29005 12X5cm



大号“数字”座牌
Table Number
编号(Code) 尺寸(Size)
LS29121 15cm



空心菜单座
Table Number
编号(Code) 尺寸(Size)
LS26003 118X61X30mm



手提毛巾篮
Handheld towel basket
编号(Code) 尺寸(Size)
LS8204 L325*W245*H190



电银牙签筒
Toothpicks Holder
编号(Code) 工艺(Surface)
LS26205 银色(Silvery)



电金牙签筒
Toothpicks Holder
编号(Code) 工艺(Surface)
LS26206 金(Golden)



天鹅水果叉套装
Fruit Set
编号(Code) 工艺(Surface)
LS26003 银色(Silvery)
LS26004 金色(Golden)



电银滴白胶牙签筒
Toothpicks Holder
编号(Code) 工艺(Surface)
LS26207 银色(Silvery)



电金滴白胶牙签筒
Toothpicks Holder
编号(Code) 工艺(Surface)
LS26008 金(Golden)



两味罐
Sauce Set 2pcs
编号(Code) 尺寸(Size)
LS26009 19cmx10.5cmx13.5cm



三味罐
Sauce Set 3pcs
编号(Code) 尺寸(Size)
LS26010 27.5cmx10.5cmx13.5cm



油醋瓶
Oil And Vinegar Set, 2pcs
编号(Code) 尺寸(Size)
LS26011 17.6cmx22cm

调味罐

生活不过是柴米油盐酱醋，
却能带来愉悦的心情，
因为品味美好的东西，
活出一种精致的仪式感





油醋瓶套装
Oil And Vinegar Set,4pcs
编号(Code) 尺寸(Size)
LS26012 140mmx160mmx224mm



油醋瓶套装
Oil And Vinegar Set,4pcs
编号(Code) 尺寸(Size)
LS26013 72X76X26mm



油粉瓶四件套
Oil Powder Bottle Set Of Four Pieces
编号(Code)
LS26035



汁碟
Sauce Dish
编号(Code) 尺寸(Size)
LS80012 8cmx15cm
LS80013 8cmx15.5cm



迷你食物薯条桶
Mini Food French Fries Bucket
编号(Code) 尺寸(Size)
LS80014 68mmx90mmx90mm



迷你食物薯条桶
Mini Food French Fries Bucket
编号(Code) 尺寸(Size)
LS80015 80mmx110mmx110mm



油醋瓶套装
Oil And Vinegar Set,5pcs
编号(Code) 尺寸(Size)
LS26015 234mmx122mm



胡椒粉筒
Salt And Pepper Set
编号(Code) 尺寸(Size)
LS26017 6x8cm
LS26018 7x9cm



酱料\盐\蒜蓉三头调味套装
Sauce, Salt, Garlic Three Head Seasoning Set
编号(Code)
LS26036



法式煎蛋筒蘸水杯
French Fry Cone Dipping Cups
编号(Code) 尺寸(Size)
LS80016 230mmx106mm



法式煎蛋筒蘸水杯
French Fry Cone Dipping Cups
编号(Code) 尺寸(Size)
LS80017 148mmx100mm



餐具桶
Cutlery Holder
编号(Code) 尺寸(Size)
LS26028 12cmx13.8cm
LS26029 11cmx13.2cm
LS26030 10cmx12.4cm



胡椒粉套装
Salt And Pepper Set
编号(Code) 尺寸(Size)
LS26020 46mmx95mm



LS26021

LS26022

胡椒粉筒套装
Salt And Pepper Set
编号(Code) 尺寸(Size)
LS26021 High 13cm wide 7cm
LS26022 High 8cm wide 7cm



LS26023

LS26025

油醋瓶
Olive Oil Orvingarsprayer
编号(Code) 尺寸(Size)
LS26023 40mmx180mm
LS26025 65mmx160mm



啤酒罐
Beer cans
编号(Code) 尺寸(Size)
LS80032-1 1.0L 12*H13cm
LS80032-2 2.0L 15*H16cm



方形小食盒(带柄)
Square small food box (with handle)
编号(Code) 尺寸(Size)
LS80030-1 10.5*10.5cm
LS80030-2 10*17cm



圆形不锈钢盘
Round stainless steel plate
编号(Code) 尺寸(Size)
LS80031-1 16cm (16.7*1.2cm)
LS80031-2 18cm(18.7*1.3cm)
LS80031-3 20cm (20.7*1.4cm)
LS80031-4 22cm(22.7*1.5cm)
LS80031-5 24cm(24.5*1.6cm)



不锈钢油醋瓶
Olive Oil Orvingarsprayer
编号(Code) 尺寸(Size)
LS26024 dia.4x18hcm



不锈钢研磨器
Stainless Steel Papper Mill
编号(Code) 尺寸(Size)
LS26027 45mmx195mm



不锈钢研磨器
Stainless Steel Papper Mill
编号(Code) 尺寸(Size)
LS26028 15cmx2.5cm



方形加深酱料格碟
Square Deepening Sauce Grid Dish
编号(Code) 尺寸(Size)
LS80027-1 7*7cm
LS80027-2 7*13cm
LS80027-3 7*19cm



304多功能托盘
MP tray
编号(Code) 尺寸(Size)
LS80028-1 40ml
LS80028-2 70ml
LS80028-3 120ml



点心托盘(加长)
Dim sum tray (lengthened)
编号(Code) 尺寸(Size)
LS80029 40*12.5cm



不锈钢304酱料碗
Stainless steel 304 sauce bowl (rose gold)

LS80026		LS80026G		LS80026M	
编号(Code)	尺寸(Size)	编号(Code)	尺寸(Size)	编号(Code)	尺寸(Size)
LS80026-1	5.5cm	LS80026-1G	5.5cm	LS80026-1M	5.5cm
LS80026-2	6cm	LS80026-2G	6cm	LS80026-2M	6cm
LS80026-3	7.2cm	LS80026-3G	7.2cm	LS80026-3M	7.2cm



不锈钢孔雀纹水杯
Stainless steel peacock patterned water cup
编号(Code) 尺寸(Size)
LS80033 7.6*5.6*12.7(H)cm 350ml



不锈钢锤双层纹水杯
Double-layer patterned water cup
编号(Code)
LS80034



不锈钢毛巾碟
Stainless steel towel dish
编号(Code)
C1617
C1617G
C1617M



方形方巾碟
Square handkerchief dish
编号(Code) 尺寸(Size)
C1618 14.8*7.3cm
C1618G 14.8*7.3cm
C1618M 14.8*7.3cm



方形锤纹毛巾碟
Square hammer pattern towel dish
编号(Code) 尺寸(Size)
C1616 14.8*7.3cm
C1616G 14.8*7.3cm
C1616M 14.8*7.3cm



锤印香槟桶
Hammer printed champagne bucket
编号(Code)
LS25326



方形方巾碟
Square handkerchief dish
编号(Code) 尺寸(Size)
C1620 14.8*7.3cm
C1620G 14.8*7.3cm
C1620M 14.8*7.3cm



树叶形筷子托
Leaf shaped chopstick mop
编号(Code)
C1331S
C1331G
C1331M

精致茶壶咖啡壶

炫朗茶壶咖啡壶，
表面光洁度高，与盖子匹配，并提供多种容量的选择

LONGWELL teapot coffee pot, with high surface finish and, the body matches the lid, and offers a variety of capacity options



Card Size



保温壶

S/S Vacuum JUG

型号(Item No)	容量(Capacity)	装箱数量
LS98203	0.35L	6只/箱
LS98206	0.6L	6只/箱
LS98210	1.0L	6只/箱
LS98215	1.5L	6只/箱
LS98220	2.0L	6只/箱



	Red
	Blue
	Mirror
	Silver



型号(Item No)	规格(Capacity)	装箱数
LS13010A	1.0L	12只/箱
LS13015A	1.5L	12只/箱
LS13020A	2.0L	12只/箱

型号(Item No)	容量(Capacity)	装箱数
LS13710F	1.0L	12只/箱
LS13715F	1.5L	12只/箱
LS13720F	2.0L	12只/箱



型号(Item No)	容量(Capacity)	装箱数
LS84320C	2.0L	6只/箱
LS84320-012	2.0L	6只/箱



型号(Item No)	容量(Capacity)	装箱数
LS80220C-001	2.0L	6只/箱
LS80220C-003	2.0L	6只/箱



型号(Item No)	容量(Capacity)	装箱数量
LS81720-002	2.0L	6只/箱



型号(Item No)	容量(Capacity)	装箱数
LS90220MCM-003	2.0L	6只/箱
LS90220MCM-012	2.0L	6只/箱



LS05001



LS51430



LS12230T



LS12130R

气压壶 S/S AIRPOT FLASK

型号(Item No)	容量(Capacity)	装箱数
LS51430	3.0L	2只/箱
型号(Item No)	名称(name)	装箱数
LS05001	气压壶底座	2只/箱
LS05002	气压壶标识套	5只/套

型号(Item No)	容量(Capacity)	装箱数
LS12230T	3.0L	6只/箱
型号(Item No)	容量(Capacity)	装箱数
LS12130R	3.0L	6只/箱



LS52108

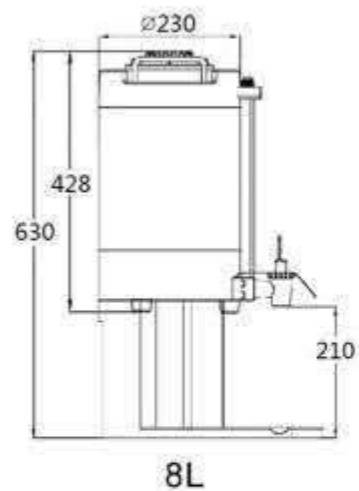

型号(Item No)	容量(Capacity)	装箱数
LS52108	8.0L	1只/箱



咖啡壶
Coffee Pot
编号(Code) 尺寸(Size)
LS15001-1 350ml
LS15001-2 800ml
LS15001-3 1000ml



咖啡壶
Coffee Pot
编号(Code) 尺寸(Size)
LS15002-1 21X9.5X16.5cm 650ml
LS15002-2 20.5X9.3X10mm 450ml
LS15002G 20.5X9.3X10mm 450ml



咖啡壶
Coffee Pot
编号(Code) 尺寸(Size)
LS15003P 26X10.5X14.5mm 420ml
LS15003-1 28X12X16mm 600ml
LS15003-2 26X10.5X14.5mm 420ml



咖啡/茶壶
Coffee/tea Pot
编号(Code) 尺寸(Size)
LS15004 6.5cmx15.3cm 1000ml



咖啡/茶壶
Coffee/tea Pot
编号(Code) 尺寸(Size)
LS15005 14.5cmX16.5cm 1500ml



咖啡/茶壶
Coffee/tea Pot
编号(Code) 尺寸(Size)
LS15006 12cmx14cm 1350ml



咖啡/茶壶加热器
Heater For Tea
编号(Code) 尺寸(Size)
LS15101 200mm 82mm



酒精燃架
Heater For Tea
编号(Code) 尺寸(Size)
LS15102 128mm 48mm



奶壶/拉花杯
Milk Jugs
编号(Code) 尺寸(Size)
LS22235 0.35L
LS22260 0.60L
LS22210 1.0L
LS22215 1.5L



不锈钢量杯
Milk Jugs With Measuring
编号(Code) 尺寸(Size) 编号(Code) 尺寸(Size)
LS22005 0.5L LS22015 1.5L
LS22007 0.7L LS22020 2.0L
LS22010 1.0L



镜光咖啡杯套装
Coffe Cup
编号(Code) 尺寸(Size)
LS15201-1 6.3X4.5X5.5cm 90ml
LS15201-2 7.2X5X6.4cm 150ml
LS15201-3 8.4X6X7.8cm 240ml



镜光咖啡杯套装
Coffe Cup
编号(Code) 尺寸(Size)
LS15202 90ml



咖啡杯
Coffee Cup
编号(Code) 尺寸(Size)
LS15204-1 47.5x37x20cm
LS15204-2 60x46.5x25.5cm
LS15204-3 35x34.5x35.5cm



凹点双层咖啡杯
Coffee Cup
编号(Code) 尺寸(Size)
LS15203 7.5XH6.8cm
LS15203-1 8.5XH7.5cm



银质杯托
Coffee Cup
编号(Code) 尺寸(Size)
LS15206 银色



欧式调酒器
Hotel table number
编号(Code) 尺寸(Size)
LS24325-1 350ml
LS24325-2 500ml
LS24325-3 750ml



带刻度鸡尾酒雪克摇杯
Hotel table number
编号(Code) 尺寸(Size)
LS24326 21.5mmX5.7mm



调酒安士杯
Alcohol measuring cup
编号(Code) 尺寸(Size)
LS24327 56ml/28ml
LS24327-24 42ml/28ml
LS24327-3 28ml/14ml



不锈钢奶盅糖罐套装
Stainless Steel Milk And Sugar Set
编号(Code) 尺寸(Size)
LS15205 57mmx60mm 70mmx62mm



红檀木柄压粉锤
Spoon holder
编号(Code) 尺寸(Size)
LS15306 58X58X95mm



不锈钢滤网
Stainless steel strainer
编号(Code) 尺寸(Size)
LS15304 132X111X86mm



镀铬酒樽头
Metal Free Pourer
编号(Code)
LS24328



量度酒樽頭
Measured Pourer
编号(Code)
LS24329



滤冰器
S/S Cocktail Ice Filtr Strainer
编号(Code)
LS24330



手冲咖啡套装
Coffee Set
编号(Code) 尺寸(Size)
LS15301 160X215X270mm



铜手冲架
Coffee Set
编号(Code) 尺寸(Size)
LS15303 108X108X86mm



不锈钢筛粉器
Stainless steel sieve powder
编号(Code) 尺寸(Size)
LS15307 73X73X115mm



碎冰锤
Ice Hammer
编号(Code)
LS24331



红酒塞
Vacuum Stoppers
编号(Code) 尺寸(Size)
LS24314 35mmx19mm



红酒塞
Vacuum Stoppers
编号(Code) 尺寸(Size)
LS24315 35mmx19mm



手冲咖啡壶
Coffee Set
编号(Code) 尺寸(Size)
LS15305-1 105X135X105mm (350ml)
LS15305-2 120X145X125mm (550ml)



压花玻璃滤杯
Coffee Set
编号(Code) 尺寸(Size)
LS14313 108X108X86mm



开瓶器
Wine Opener
编号(Code)
LS24317



开瓶器
Wine Opener
编号(Code) 尺寸(Size)
LS24318 15cm



开瓶器
Cork Screw
编号(Code) 尺寸(Size)
LS24221 180mmx80mm



开瓶器

Cork Screw

编号(Code) 尺寸(Size)
LS24222 185mmx70mm



开瓶器

Bottle Opener

编号(Code) 尺寸(Size)
LS24316 18cmX4cm



带盖提手双层冰桶

Double wall ice bucket

编号(Code) 尺寸(Size)
LS25322 14cmX14cm 1L



手提腰形冰桶

Double wall ice bucket

编号(Code) 尺寸(Size)
LS25309-1 17cmX13cm 1L
LS25309-2 22.5cmX14cm 2L



茶餐厅冰桶

Ice Buket

编号(Code) 尺寸
LS25320 14.5cmx13.5cm



锤点冰桶镀铜冰粒桶

Ice Buket

编号(Code) 尺寸(Size)
LS25321 11X12cm



豪华香槟桶

Ice Buket

编号(Code) 工艺 尺寸(Size)
LS25308-1 银耳 190x220mm 4.5L
LS25308-2 金耳 190x220mm 4.5L



(欧式) 不锈钢香槟桶

Ice Buket

编号(Code) 工艺 尺寸(Size)
LS25323 银耳 190XH220mm 4.5L
LS25323G 金耳 190XH220mm 4.5L



不锈钢双层冰桶

Double wall ice bucket

编号(Code) 尺寸(Size)
LS25311 13X25cm 1.3L



不锈钢双层冰桶

Double wall ice bucket

编号(Code)	尺寸(Size)	高度	大小
LS25310-1	110	200	1L
LS25310-2	125	220	2L



LS25307

LS25324

(欧式) 不锈钢香槟桶架

stand for wine/champagne cooler

编号(Code)	尺寸(Size)
Ls25324	Φ200X750mm
LS25324-1	Φ200X610mm
Ls25307	Φ190X750mm
LS25307-1	Φ190X610mm



电镀玫瑰金滨治盆

Stainless steel wine rack

编号(Code)	大小(Size)	尺寸(Desc.)
LS25325	10L	D398XH245mm